











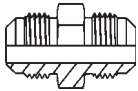
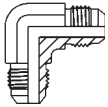
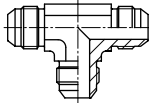
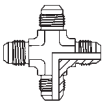
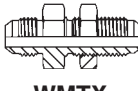
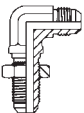
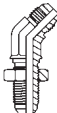
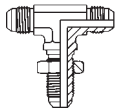
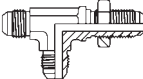

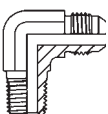
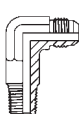
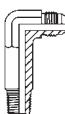
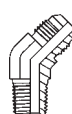
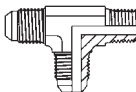
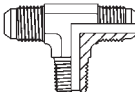
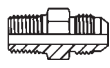
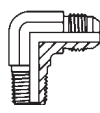
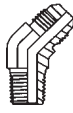
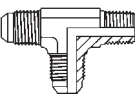
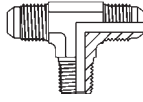

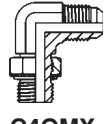



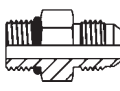
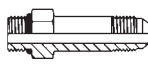
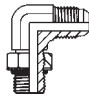
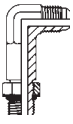

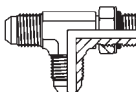
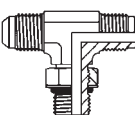

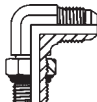

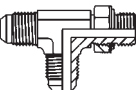
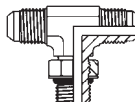
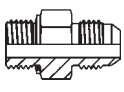
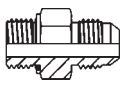
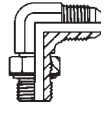

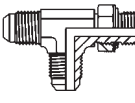
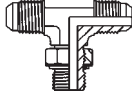

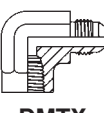

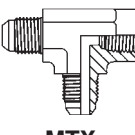
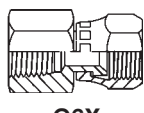

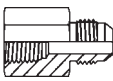
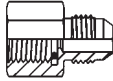

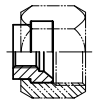
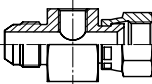
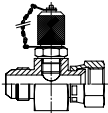
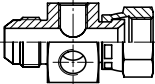
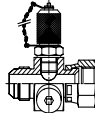
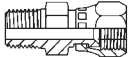

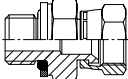
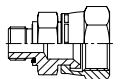

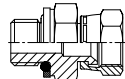
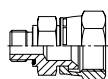
Triple-Lok[®]

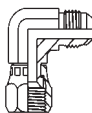
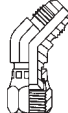
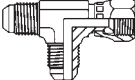
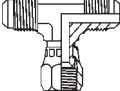
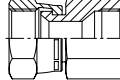
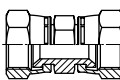
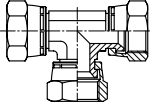
*Die vielseitige
37° Bördelverschraubung*

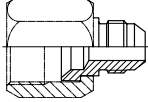
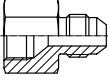

Allgemeine Übersicht

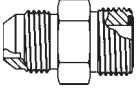
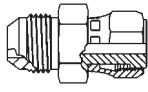
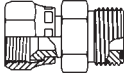
Von Rohr auf Rohr	 HMTX S. K9	 EMTX S. K10	 JMTX S. K11	 KTX S. K14			
Schottverschraubung	 WMTX S. K15	 WEMTX S. K16	 WNTX S. K17	 WJTX S. K18	 WJJTX S. K19	 WLNМ S. K92	
Von Rohr auf NPTF-Außengewinde	 FMTX S. K36	 CMTX S. K51	 CCTX S. K52	 CCCTX S. K53	 VMTX S. K59	 RMTX S. K71	 SMTX S. K65
Von Rohr auf BSPT-Außengewinde	 F3MX S. K37	 C3MX S. K54	 V3MX S. K60	 R3MX S. K72	 S3MX S. K66		
Von Rohr auf BSPA-Außengewinde	 F4OMX S. K33	 F42EDMX S. K32	 C4OMX S. K49	 V4OMX S. K57	 R4OMX S. K69	 S4OMX S. K63	
Von Rohr auf zylindrische UNF-Gewinde	 F5OMX S. K29	 FF5OMX S. K31	 C5OMX S. K47	 CC5OX S. K48	 V5OMX S. K56	 R5OMX S. K68	 S5OMX S. K62
Von Rohr auf metrisches Außengewinde nach ISO 6149-3	 F87OMX S. K28	 C87OMX S. K46	 V87OMX S. K55	 R87OMX S. K67	 S87OMX S. K61		
Von Rohr auf metrisches Außengewinde nach DIN 3852-1	 F8OMX S. K35	 F82EDMX S. K34	 C8OMX S. K50	 V8OMX S. K58	 R8OMX S. K70	 S8OMX S. K64	
Von Rohr auf NPTF-Innengewinde	 GMTX S. K74	 WGMTX S. K75	 DMTX S. K76	 OTX S. K77	 MTX S. K78	 G6X S. K79	

Prüfanschlüsse Manometer- verschraubung							
	G4MX S. K73	G4MXMO S. K80	TT4MX S. K81	TTP4MX S. K82			
							
	R604MX S. K83	R6P4MX S. K84	K6004MX S. K85	K6PP4MX S. K86			
Einstellbare Einschraub- adapter, kegeliges Außengewinde							
	F6MX S. K44	F63MX S. K45					
Einstellbare Einschraub- adapter, zylindrisches Außengewinde							
	F64OMX S. K41	F642EDMX S. K40	F65OMX S. K39	F68OMX S. K43	F682EDMX S. K42	F687OMX S. K38	
Einstellbare Aufschraubver- schraubungen							
	C6MX S. K20	V6MX S. K21	R6MX S. K23	S6MX S. K22	BBMTX S. K24	HMX6 S. K26	JX6 S. K27
Überwurf- muttern/ Stützhülsen							
	BMTX S. K6	BTX S. K5	TX S. K7				
Verschluss- teile, Reduzierungen							
		TRMTX S. K25	FNMTX S. K87	PNMTX S. K88			
Triple-Lok®-/ O-Lok®- Adapter							
	XHML0 S. K89	XHML6 S. K90	LOHMX6 S. K91				
Dichtungen/ Kammerringe							
	Triple-Lok® Components S. K93						



Bestellzeichen Triple-Lok®-Verschraubungen

Beispiel Bestellzeichen **6-8 C 5 O M X S**

1 Größenkürzel für Rohre und Gewindeanschlüsse

Größe	Rohr Größe (Zoll)	Rohr Größe (mm)	Gewinde Größe (Zoll) BSPP/BSPT/NPT	Gewinde Größe UN / UNF
2	1/8		1/8	5/16-24
3	3/16			3/8-24
4	1/4	6	1/4	7/16-20
5				1/2-20
6	3/8	8,10	3/8	9/16-18
8	1/2	12	1/2	3/4-16
10	5/8	14,15,16	5/8	7/8-14
12	3/4	18,20	3/4	1 1/6-12
14				1 3/6-12
16	1	25	1	1 5/6-12
20	1 1/4	28,30,32	1 1/4	1 5/8-12
24	1 1/2	35,38	1 1/2	1 7/8-12
28		42		2 1/4-12
32	2	50	2	2 1/2-12

Beispiel metrisches Gewinde 4M12C87OMXS

3 Gewinde- und Dichtungsarten

Kürzel	Beschreibung
Kein Kürzel	NPT/NPTF Gewinde
3	BSPT Gewinde
4	BSPP Gewinde, O-Ring & Haltering
42	BSPP Gewinde EOLASTIC Dichtung ,ED'
5	UN/UNF Gewinde (O-Ring Dichtung)
8	Metrisches Gewinde O-Ring & Haltering
82	Metrisches Gewinde EOLASTIC Dichtung ,ED'
87	Metrisches ISO 6149 Gewinde (O-Ring Dichtung)
63	Stutzen einstellbar BSPT Anschluss
64	Stutzen einstellbar BSPP Anschluss (O-Ring & Haltering)
642	Stutzen einstellbar BSPP Anschluss (EOLASTIC Dichtung ,ED')
65	Stutzen einstellbar UN/UNF Anschluss (O-Ring Dichtung)
68	Stutzen einstellbar metrischer Anschluss (O-Ring & Haltering)
682	Stutzen einstellbar metrischer Anschluss (EOLASTIC Dichtung ,ED')
687	Stutzen einstellbar metrischer ISO 6149 Anschluss

2 Bestellzeichen für Verschraubungen

Kürzel	Beschreibung
AE6	Winkel-Einschraubstutzen einstellbar
B	Mutter
C	Winkel-Einschraubstutzen
CC	Winkel-Einschraubstutzen mit langem Schaft
CCC	Winkel-Einschraubstutzen mit extra langem Schaft
C6	Winkelstutzen einstellbar
D	Winkelaufschraubstutzen
E	Winkelstutzen
F	Gerade-Einschraubstutzen
FF	Lange-Einschraubstutzen
F6	Einschraubstutzen einstellbar
FN	Verschlussstutzen
G	Gerader-Aufschraubstutzen
G-MO	Manometerverschraubung
G6	Gerader-Aufschraubstutzen einstellbar
H	Gerader-Stutzen
H6	Gerader-Stutzen einstellbar
J	T-Stutzen
J6	T-Stutzen einstellbar
K	Kreuz-Stutzen
LOHX6	37° einstellbarer Adapter
M	L-Aufschraubstutzen
O	T-Aufschraubstutzen
PN	Rohrverschluss
R	L-Einschraubstutzen
R6	L-Einschraubstutzen einstellbar
S	T-Einschraubstutzen
S6	T-Einschraubstutzen einstellbar
T	Hülse
TR	Reduzierstutzen
TT	Triple-Lok®-Prüfanschluss
V	Winkel-Einschraubstutzen 45°
V6	Winkel-Einschraubstutzen 45° einstellbar
W	Schottstutzen
WE	Winkelschottstutzen
WG	Schottaufschraubstutzen
WJJ	L-Schottstutzen
WJT	T-Schottstutzen
WLN	Gegenmutter mit Schottstutzen
WN	Winkelschottstutzen 45°
XHL	Triple-Lok® / O-Lok® Adapter
XHL6	37° Übergangsadapter einstellbar

4 Stutzen-Dichtung

Kürzel	Beschreibung
O	O-Ring Dichtung (auf Stutzen montiert)
ED	unverlierbare EOLASTIC Dichtung
Kein Kürzel	Keine Dichtung

5 Schlüsselflächen

Kürzel	Beschreibung
M	Metrische Schlüsselfläche/ Sechskant
Kein Kürzel	Zöllige Schlüsselfläche/ Sechskant

6 Verschraubungsart

Kürzel	Beschreibung
X	Parker Triple-Lok®

7 Verschraubungsmaterial

Kürzel	Beschreibung
S	Stahl
SS	Edelstahl
B	Messing

BTX Überwurfmutter

Triple-Lok® 37° Bördelanschluss
SAE 070110 MS51531

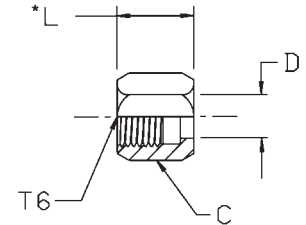

Rohr A.D. mm	Zoll	Gewinde UN/UNF-2B T6	C Zoll	D mm	L mm	Gewicht (Stahl) g/1 St.	Triple-Lok®		
							Stahl	Edelstahl	Messing
6	1/8	5/16-24	3/8	5	14	6	2 BTX-S	2 BTX-SS	2 BTX-B
	3/16	3/8-24	7/16	6	16	8	3 BTX-S	3 BTX-SS	3 BTX-B
	1/4	7/16-20	9/16	8	16	11	4 BTX-S	4 BTX-SS	4 BTX-B
	5/16	1/2-20	5/8	10	17	14	5 BTX-S	5 BTX-SS	5 BTX-B
	3/8	9/16-18	11/16	11	18	18	6 BTX-S	6 BTX-SS	6 BTX-B
12	1/2	3/4-16	7/8	15	22	29	8 BTX-S	8 BTX-SS	8 BTX-B
	5/8	7/8-14	1	18	25	54	10 BTX-S	10 BTX-SS	10 BTX-B
	3/4	1 1/16-12	1 1/4	21	26	73	12 BTX-S	12 BTX-SS	12 BTX-B
	7/8	1 3/16-12	1 3/8	24	28	100	14 BTX-S	14 BTX-SS	14 BTX-B
	1	1 5/16-12	1 1/2	28	29	104	16 BTX-S	16 BTX-SS	16 BTX-B
28, 30, 32	1 1/4	1 5/8-12	2	34	31	240	20 BTX-S	20 BTX-SS	20 BTX-B
	1 1/2	1 7/8-12	2 1/4	41	36	325	24 BTX-S	24 BTX-SS	24 BTX-B
35, 38	2	2 1/2-12	2 7/8	55	45	549	32 BTX-S	32 BTX-SS	32 BTX-B

Die angegebenen Artikel entsprechen unserem Standard-Lieferprogramm.



BMTX Überwurfmutter

Triple-Lok® 37° Bördelanschluss
SAE 070110

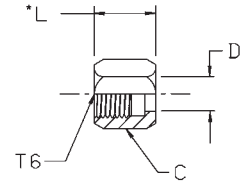

Rohr A.D.		Gewinde UN/UNF-2B T6	C mm	D mm	L mm	Gewicht (Stahl) g/1 St.	Triple-Lok® Stahl	Triple-Lok® Edelstahl
mm	Zoll							
6	1/4	7/16-20	14	8	16	11	4BMTXS	4BMTXSS
8	5/16	1/2-20	17	10	17	14	5BMTXS	5BMTXSS
10	3/8	9/16-18	19	11	18	18	6BMTXS	6BMTXSS
12	1/2	3/4-16	22	15	21	29	8BMTXS	8BMTXSS
14, 15, 16	5/8	7/8-14	27	18	25	42	10BMTXS	10BMTXSS
18, 20	3/4	1 1/16-12	32	22	26	73	12BMTXS	12BMTXSS
25	1	1 5/16-12	41	28	28	104	16BMTXS	16BMTXSS
28, 30, 32	1 1/4	1 5/8-12	50	34	31	240	20BMTXS	20BMTXSS
35, 38	1 1/2	1 7/8-12	60	41	36	325	24BMTXS	24BMTXSS
42		2 1/4	65	48	40	437	28BMTXS	28BMTXSS

Die angegebenen Artikel entsprechen unserem Standard-Lieferprogramm.

TX Hülsen

Triple-Lok® 37° Stützhülsen für metrische Rohraußendurchmesser
SAE 070105 MS51533

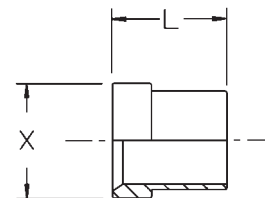

Rohr A.D. mm	L mm	X mm	Gewicht (Stahl) g/1 St.	Triple-Lok® Stahl	Triple-Lok® Edelstahl	Triple-Lok® Messing
6	10	10	2	TXS6	TXSS6	TXB6
8	11	11	2	TXS8	TXSS8	TXB8
10	13	13	2	TXS10	TXSS10	TXB10
12	14	17	7	TXS12	TXSS12	TXB12
14	17	20	13	TXS14	TXSS14	TXB14
15	17	20	10	TXS15	TXSS15	TXB15
16	17	20	7	TXS16	TXSS16	TXB16
18	17	25	16	TXS18	TXSS18	TXB18
20	17	25	12	TXS20	TXSS20	TXB20
22	19	28	25	TXS22	TXSS22	TXB22
25	20	31	21	TXS25	TXSS25	TXB25
28	23	39	40	TXS28	TXSS28	TXB28
30	23	39	45	TXS30	TXSS30	TXB30
32	23	39	30	TXS32	TXSS32	TXB32
35	28	45	60	TXS35	TXSS35	TXB35
38	28	45	51	TXS38	TXSS38	TXB38
42	29	55	149	TXS42	TXSS42	TXB42

Die angegebenen Artikel entsprechen unserem Standard-Lieferprogramm.

K

TX Hülsen

Triple-Lok® 37° Stützhülsen für zöllige Rohraußendurchmesser
SAE 070105 MS51533

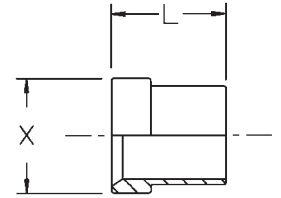

Rohr A.D. Zoll	L mm	X mm	Gewicht (Stahl) g/1 St.	Triple-Lok® Stahl	Triple-Lok® Edelstahl	Triple-Lok® Messing
1/8	9	7	2	2 TX-S	2 TX-SS	2 TX-B
3/16	9	8	2	3 TX-S	3 TX-SS	3 TX-B
1/4	10	10	2	4 TX-S	4 TX-SS	4 TX-B
5/16	11	11	2	5 TX-S	5 TX-SS	5 TX-B
3/8	13	13	3	6 TX-S	6 TX-SS	6 TX-B
1/2	14	17	6	8 TX-S	8 TX-SS	8 TX-B
5/8	17	20	8	10 TX-S	10 TX-SS	10 TX-B
3/4	17	25	13	12 TX-S	12 TX-SS	12 TX-B
7/8	19	28	18	14 TX-S	14 TX-SS	14 TX-B
1	20	31	23	16 TX-S	16 TX-SS	16 TX-B
1 1/4	23	39	30	20 TX-S	20 TX-SS	20 TX-B
1 1/2	28	45	51	24 TX-S	24 TX-SS	24 TX-B
2	30	61	156	32 TX-S	32 TX-SS	32 TX-B

Die angegebenen Artikel entsprechen unserem Standard-Lieferprogramm.

HMTX Gerader Stutzen

Triple-Lok® 37° Bördelanschluss
SAE 070101 MS51501

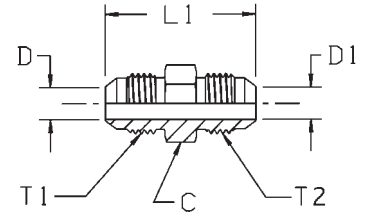

Rohr 1 A.D.		Rohr 2 A.D.		Gewinde UN/UNF-2A T1	Gewinde UN/UNF-2A T2	C	D	D1	L1	Gewicht (Stahl) g/1 St.	Triple-Lok® Stahl	Triple-Lok® Edelstahl	Triple-Lok® Messing	PN (bar)		
mm	Zoll	mm	Zoll			mm	mm	mm	mm					S	SS	
6	1/8	6	1/8	5/16-24	5/16-24	11	2	2	30	9	2 HTX-S	4HMTXSS	4HMTXB	500	—	
	3/16		3/16	3/8-24	3/8-24	11	3	3	31	10	3 HTX-S			500	—	
	1/4		1/4	7/16-20	7/16-20	13	4	4	35	16	4HMTXS			500	350	
	1/4		1/8	7/16-20	5/16-24	13	5	2	32	12	4-2 HTX-S			4-2HMTXSS	4-2HMTXB	500
6	1/4	6	3/16	7/16-20	3/8-24	13	5	3	33	14	4-3 HTX-S	4-3HMTXSS	4-3HMTXB	500	350	
8	5/16		8	5/16	1/2-20	1/2-20	14	6	6	35	18	5HMTXS	5HMTXSS	5HMTXB	420	350
8	5/16		6	1/4	1/2-20	7/16-20	14	6	5	35	18	5-4 HTX-S	5-4HMTXSS	5-4HMTXB	420	350
10	3/8		10	3/8	9/16-18	9/16-18	17	8	8	36	25	6HMTXS	6HMTXSS	6HMTXB	420	350
10	3/8	10	6	1/4	9/16-18	7/16-20	17	8	4	36	22	6-4HMTXS	6-4HMTXSS	6-4HMTXB	420	350
10	3/8		8	5/16	9/16-18	1/2-20	17	8	6	36	25	6-5 HTX-S	6-5HMTXSS	6-5HMTXB	420	350
12	1/2		12	1/2	3/4-16	3/4-16	19	10	10	41	52	8HMTXS	8HMTXSS	8HMTXB	420	350
12	1/2		6	1/4	3/4-16	7/16-20	21	10	5	39	45	8-4 HTX-S	8-4HMTXSS	8-4HMTXB	420	350
12	1/2	14, 15,16	10	3/8	3/4-16	9/16-18	19	10	8	39	45	8-6HMTXS	8-6HMTXSS	8-6HMTXB	420	350
14, 15,16	5/8		14, 15,16	5/8	7/8-14	7/8-14	24	12	12	48	80	10HMTXS	10HMTXSS	10HMTXB	350	350
14, 15,16	5/8		10	3/8	7/8-14	9/16-18	24	13	8	43	60	10-6HMTXS	10-6HMTXSS	10-6HMTXB	350	350
14, 15,16	5/8		12	1/2	7/8-14	3/4-16	24	12	10	45	68	10-8HMTXS	10-8HMTXSS	10-8HMTXB	350	350
18, 20	3/4	18, 20	3/4	1 1/16-12	1 1/16-12	27	16	16	55	125	12HMTXS	12HMTXSS	12HMTXB	350	350	
18, 20	3/4		12	1/2	1 1/16-12	3/4-16	29	16	10	50	101	12-8 HTX-S	12-8HMTXSS	12-8HMTXB	350	350
20	3/4		14, 15,16	5/8	1 1/16-12	7/8-14	29	16	12	52	113	12-10HMTXS	12-10HMTXSS	12-10HMTXB	350	350
22	7/8		22	7/8	1 3/16-12	1 3/16-12	32	18	18	56	156	14 HTX-S	14HMTXSS	14HMTXB	280	280
25	1	28, 30, 32	25	1	1 5/16-12	1 5/16-12	36	22	22	57	131	16HMTXS	16HMTXSS	16HMTXB	280	280
25	1		20	3/4	1 5/16-12	1 1/16-12	36	22	16	56	169	16-12HMTXS	16-12HMTXSS	16-12HMTXB	280	280
28, 30, 32	1 1/4		28, 30, 32	1 1/4	1 5/8-12	1 5/8-12	46	28	28	62	271	20HMTXS	20HMTXSS	20HMTXB	280	210
28, 30, 32	1 1/4		25	1	1 5/8-12	1 5/16-12	46	28	22	61	235	20-16HMTXS	20-16HMTXSS	20-16HMTXB	280	210
35, 38	1 1/2	42	35, 38	1 1/2	1 7/8-12	1 7/8-12	50	33	33	70	382	24HMTXS	24HMTXSS	24HMTXB	210	210
42			42		2 1/4-12	2 1/4-12	60	39	39	71	469	28HMTXS	28HMTXSS	28HMTXB	140	150
	2		2		2 1/2-12	2 1/2-12	67	45	45	87	785	32 HTX-S	32HMTXSS	32HMTXB	140	150

Die angegebenen Artikel entsprechen unserem Standard-Lieferprogramm.
Zöllige und metrische Versionen können sich in der Schlüsselweite unterscheiden.

$$\frac{\text{PN (bar)}}{10} = \text{PN (MPa)}$$

Die angegebenen Nenndrücke PN beziehen sich auf die Stahl- und Edelstahlversion der Verschraubung.
Für Messingverschraubungen sind diese Drücke um 35% zu reduzieren.

EMTX Winkelstutzen

Triple-Lok® 37° Bördelanschluss
SAE 070201 MS51505

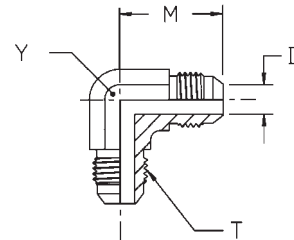

Rohr A.D. mm	Zoll	Gewinde UN/UNF-2A T	D Zoll	M mm	Y mm	Gewicht (Stahl) g/1 St.	Triple-Lok® Stahl	Triple-Lok® Edelstahl	Triple-Lok® Messing	PN (bar)	
										S	SS
6	1/8	5/16-24	2	20	11	18	2 ETX-S			500	—
	3/16	3/8-24	3	21	11	20	3 ETX-S			500	—
	1/4	7/16-20	4	23	11	25	4EMTXS	4EMTXSS	4 ETX-B	500	350
	5/16	1/2-20	6	24	13	32	5EMTXS	5EMTXSS	5 ETX-B	420	350
10	3/8	9/16-18	8	27	14	44	6EMTXS	6EMTXSS	6 ETX-B	420	350
	3/8	5/16-24	8	27	14	40	6-4 ETX-S	6-4EMTXSS	6-4 ETX-B	420	350
12	1/2	3/4-16	10	32	19	88	8EMTXS	8EMTXSS	8 ETX-B	420	350
	1/2	3/8-24	10	32	19	75	8-6 ETX-S	8-6EMTXSS		420	—
14, 15,16	5/8	7/8-14	12	37	22	139	10EMTXS	10EMTXSS	10 ETX-B	350	350
	5/8	7/8-14	12	37	22	120	10-8 ETX-S	10-8EMTXSS	10-8 ETX-B	350	350
18, 20	3/4	1 1/16-12	16	42	27	258	12EMTXS	12EMTXSS	12 ETX-B	350	350
	3/4	7/16-20	16	42	27	220	12-8 ETX-S	12-8EMTXSS		350	—
18, 20	3/4	3/4-16	16	42	27	240	12-10 ETX-S	12-10EMTXSS		350	—
	7/8	1 3/16-12	18	44	30	273	14 ETX-S	14EMTXSS		280	—
22, 25	1	1 5/16-12	22	46	33	333	16EMTXS	16EMTXSS	16 ETX-B	280	280
	1	1/2-20	22	46	33	310	16-12 ETX-S	16-12EMTXSS	16-12 ETX-B	280	280
28, 30, 32	1 1/4	1 5/8-12	28	52	41	586	20EMTXS	20EMTXSS	20 ETX-B	280	210
	1 1/2	1 7/8-12	33	59	48	778	24EMTXS	24EMTXSS	24 ETX-B	210	140
35, 38	42	2 1/4-12	39	74	63	1100	28 ETX-S			140	—
	2	2 1/2-12	45	78	64	1680	32 ETX-S			140	—

Die angegebenen Artikel entsprechen unserem Standard-Lieferprogramm.
Zöllige und metrische Versionen können sich in der Schlüsselweite unterscheiden.

$$\frac{\text{PN (bar)}}{10} = \text{PN (MPa)}$$

Die angegebenen Nenndrücke PN beziehen sich auf die Stahl- und Edelstahlversion der Verschraubung.
Für Messingverschraubungen sind diese Drücke um 35% zu reduzieren.

JMTX T-Stutzen

Triple-Lok® 37° Bördelanschluss
SAE 070401 MS51510

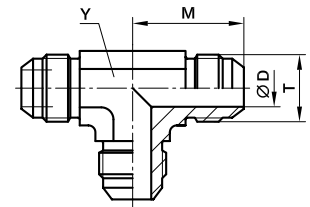

Rohr A.D. mm	Zoll	Gewinde UN/UNF-2A T	D Zoll	M mm	Y mm	Gewicht (Stahl) g/1 St.	Triple-Lok® Stahl	Triple-Lok® Edelstahl	Triple-Lok® Messing	PN (bar)	
										S	SS
6	1/8	5/16-24	2	20	8	25	2 JTX-S			500	—
	3/16	3/8-24	3	21	11	30	3 JTX-S			500	—
	1/4	7/16-20	4	23	11	33	4JMTXS	4JMTXSS	4 JTX-B	500	350
	5/16	1/2-20	6	24	13	42	5JMTXS	5JMTXSS	5 JTX-B	420	350
10	3/8	9/16-18	8	27	14	53	6JMTXS	6JMTXSS	6 JTX-B	420	350
	1/2	3/4-16	10	32	19	118	8JMTXS	8JMTXSS	8 JTX-B	420	350
14, 15,16	5/8	7/8-14	12	37	22	182	10JMTXS	10JMTXSS	10 JTX-B	350	350
	3/4	1 1/16-12	16	42	27	291	12JMTXS	12JMTXSS	12 JTX-B	350	350
22	7/8	1 3/16-12	18	44	33	403	14 JTX-S	14JMTXSS	14 JTX-B	280	245
	1	1 5/16-12	22	46	33	415	16JMTXS	16JMTXSS	16 JTX-B	280	280
28, 30, 32	1 1/4	1 5/8-12	28	52	41	706	20JMTXS	20JMTXSS	20 JTX-B	280	210
	1 1/2	1 7/8-12	33	59	48	990	24 JTX-S	24JMTXSS	24 JTX-B	210	140
35, 38	1 1/2	2 1/4-12	39	74	63	2270	28 JTX-S			140	—
		2 1/2-12	45	78	66	2450	32 JTX-S			140	—

Die angegebenen Artikel entsprechen unserem Standard-Lieferprogramm.
Zöllige und metrische Versionen können sich in der Schlüsselweite unterscheiden.

$$\frac{\text{PN (bar)}}{10} = \text{PN (MPa)}$$

Die angegebenen Nenndrücke PN beziehen sich auf die Stahl- und Edelstahlversion der Verschraubung.
Für Messingverschraubungen sind diese Drücke um 35% zu reduzieren.

K

JMTX T-Reduzier-Stutzen

Triple-Lok® 37° Bördelanschluss
SAE 070401 MS51510

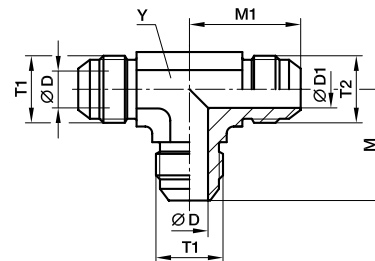

Rohr 1 A.D.		Rohr 2 A.D.		Gewinde UN/UNF-2A T1	Gewinde UN/UNF-2A T2	D mm	D1 mm	M mm	M1 mm	Y mm	Gewicht (Stahl) g/1 St.	Triple-Lok® Stahl	Triple-Lok® Edelstahl	PN (bar)	
mm	Zoll	mm	Zoll											S	SS
10	3/8	6	1/4	9/16-18	7/16-20	8	4	27	27	14	50	6-4-6JMTXS	6-4-6JMTXSS	420	350
12	1/2	6	1/4	3/4-16	7/16-20	10	4	32	29	19	96	8-4-8JMTXS	8-4-8JMTXSS	420	350
12	1/2	10	3/8	3/4-16	9/16-18	10	8	32	29	19	102	8-6-8JMTXS	8-6-8JMTXSS	420	350
14, 15, 16	5/8	6	1/4	7/8-14	7/16-20	12	4	37	31	22	156	10-4-10JMTXS	10-4-10JMTXSS	350	350
14, 15, 16	5/8	10	3/8	7/8-14	9/16-18	12	8	37	31	22	167	10-6-10JMTXS	10-6-10JMTXSS	350	350
14, 15, 16	5/8	12	1/2	7/8-14	3/4-16	12	10	37	34	22	175	10-8-10JMTXS	10-8-10JMTXSS	350	350
18, 20	3/4	6	1/4	1 1/16-12	7/16-20	16	4	42	33	27	234	12-4-12JMTXS	12-4-12JMTXSS	350	350
18, 20	3/4	10	3/8	1 1/16-12	9/16-18	16	8	42	33	27	249	12-6-12JMTXS	12-6-12JMTXSS	350	350
18, 20	3/4	12	1/2	1 1/16-12	3/4-16	16	10	42	36	27	265	12-8-12JMTXS	12-8-12JMTXSS	350	350
18, 20	3/4	14/15/16	5/8	1 1/16-12	7/8-14	16	12	42	39	27	283	12-10-12JMTXS	12-10-12JMTXSS	350	350
25	1	10	3/8	1 5/16-12	9/16-18	22	8	46	36	33	326	16-6-16JMTXS	16-6-16JMTXSS	280	280
25	1	12	1/2	1 5/16-12	3/4-16	22	10	46	39	33	354	16-8-16JMTXS	16-8-16JMTXSS	280	280
25	1	14/15/16	5/8	1 5/16-12	7/8-14	22	12	46	42	33	379	16-10-16JMTXS	16-10-16JMTXSS	280	280
25	1	18/20	3/4	1 5/16-12	1 1/16-12	22	16	46	45	33	396	16-12-16JMTXS	16-12-16JMTXSS	280	280
28, 30, 32	1 1/4	12	1/2	1 5/8-12	3/4-16	28	10	52	44	41	478	20-8-20JMTXS	20-8-20JMTXSS	280	210
28, 30, 32	1 1/4	14/15/16	5/8	1 5/8-12	7/8-14	28	12	52	47	41	526	20-10-20JMTXS	20-10-20JMTXSS	280	210
28, 30, 32	1 1/4	18/20	3/4	1 5/8-12	1 1/16-12	28	16	52	50	41	628	20-12-20JMTXS	20-12-20JMTXSS	280	210
28, 30, 32	1 1/4	25	1	1 5/8-12	1 5/16-12	28	22	52	51	41	673	20-16-20JMTXS	20-16-20JMTXSS	280	210

Die angegebenen Artikel entsprechen unserem Standard-Lieferprogramm.
Zöllige und metrische Versionen können sich in der Schlüsselweite unterscheiden.

$$\frac{\text{PN (bar)}}{10} = \text{PN (MPa)}$$

Die angegebenen Nenndrücke PN beziehen sich auf die Stahl- und Edelstahlversion der Verschraubung.

JMTX T-Reduzier-Stutzen

Triple-Lok® 37° Bördelanschluss
SAE 070401 MS51510

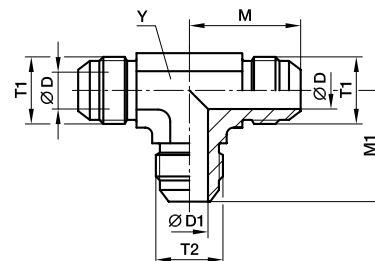

Rohr 1 A.D.		Rohr 2 A.D.		Gewinde UN/UNF-2A T1	Gewinde UN/UNF-2A T2	D mm	D1 mm	M mm	M1 mm	Y mm	Gewicht (Stahl) g/1 St.	Triple-Lok® Stahl	Triple-Lok® Edelstahl	PN (bar)	
mm	Zoll	mm	Zoll											S	SS
10	3/8	6	1/4	9/16-18	7/16-20	8	4	27	27	14	50	6-6-4JMTXS	6-6-4JMTXSS	420	350
12	1/2	6	1/4	3/4-16	7/16-20	10	4	32	29	19	96	8-8-4JMTXS	8-8-4JMTXSS	420	350
12	1/2	10	3/8	3/4-16	9/16-18	10	8	32	29	19	102	8-8-6JMTXS	8-8-6JMTXSS	420	350
14, 15, 16	5/8	6	1/4	7/8-14	7/16-20	12	4	37	31	22	156	10-10-4JMTXS	10-10-4JMTXSS	350	350
14, 15, 16	5/8	10	3/8	7/8-14	9/16-18	12	8	37	31	22	167	10-10-6JMTXS	10-10-6JMTXSS	350	350
14, 15, 16	5/8	12	1/2	7/8-14	3/4-16	12	10	37	34	22	175	10-10-8JMTXS	10-10-8JMTXSS	350	350
18, 20	3/4	6	1/4	1 1/16-12	7/16-20	16	4	42	33	27	234	12-12-4JMTXS	12-12-4JMTXSS	350	350
18, 20	3/4	10	3/8	1 1/16-12	9/16-18	16	8	42	33	27	249	12-12-6JMTXS	12-12-6JMTXSS	350	350
18, 20	3/4	12	1/2	1 1/16-12	3/4-16	16	10	42	36	27	265	12-12-8JMTXS	12-12-8JMTXSS	350	350
18, 20	3/4	14/15/16	5/8	1 1/16-12	7/8-14	16	12	42	39	27	283	12-12-10JMTXS	12-12-10JMTXSS	350	280
25	1	10	3/8	1 5/16-12	9/16-18	22	8	46	36	33	326	16-16-6JMTXS	16-16-6JMTXSS	280	280
25	1	12	1/2	1 5/16-12	3/4-16	22	10	46	39	33	354	16-16-8JMTXS	16-16-8JMTXSS	280	280
25	1	14/15/16	5/8	1 5/16-12	7/8-14	22	12	46	42	33	379	16-16-10JMTXS	16-16-10JMTXSS	280	280
25	1	18/20	3/4	1 5/16-12	1 1/16-12	22	16	46	45	33	396	16-16-12JMTXS	16-16-12JMTXSS	280	210
28, 30, 32	1 1/4	12	1/2	1 5/8-12	3/4-16	28	10	52	44	41	478	20-20-8JMTXS	20-20-8JMTXSS	280	210
28, 30, 32	1 1/4	14/15/16	5/8	1 5/8-12	7/8-14	28	12	52	47	41	526	20-20-10JMTXS	20-20-10JMTXSS	280	210
28, 30, 32	1 1/4	18/20	3/4	1 5/8-12	1 1/16-12	28	16	52	50	41	628	20-20-12JMTXS	20-20-12JMTXSS	280	210
28, 30, 32	1 1/4	25	1	1 5/8-12	1 5/16-12	28	22	52	51	41	673	20-20-16JMTXS	20-20-16JMTXSS	280	210

Die angegebenen Artikel entsprechen unserem Standard-Lieferprogramm.
Zöllige und metrische Versionen können sich in der Schlüsselweite unterscheiden.

$$\frac{\text{PN (bar)}}{10} = \text{PN (MPa)}$$

Die angegebenen Nenndrücke PN beziehen sich auf die Stahl- und Edelstahlversion der Verschraubung.



KTX Kreuzstutzen

Triple-Lok® 37° Bördelanschluss
SAE 070501 MS51517

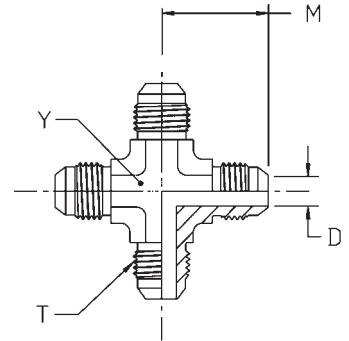

Rohr A.D.		Gewinde UN/UNF-2A T	D mm	M mm	Y mm	Gewicht (Stahl) g/1 St.	Triple-Lok® Stahl	Triple-Lok® Edelstahl	Triple-Lok® Messing	PN (bar)	
mm	Zoll									S	SS
6	1/4	7/16-20	4	23	11	41	4 KTX-S	4 KTX-SS	4 KTX-B	500	350
8	5/16	1/2-20	6	24	14	50	5 KTX-S	5 KTX-SS	5 KTX-B	420	350
10	3/8	9/16-18	8	27	14	68	6 KTX-S	6 KTX-SS	6 KTX-B	420	350
12	1/2	3/4-16	10	32	19	144	8 KTX-S	8 KTX-SS	8 KTX-B	420	350
14, 15, 16	5/8	7/8-14	12	37	22	220	10 KTX-S	10 KTX-SS	10 KTX-B	350	350
18, 20	3/4	1 1/16-12	16	42	27	345	12 KTX-S	12 KTX-SS	12 KTX-B	350	350
25	1	1 5/16-12	22	46	33	588	16 KTX-S	16 KTX-SS	16 KTX-B	280	280

Die angegebenen Artikel entsprechen unserem Standard-Lieferprogramm.
Zöllige und metrische Versionen können sich in der Schlüsselweite unterscheiden.

$$\frac{\text{PN (bar)}}{10} = \text{PN (MPa)}$$

Die angegebenen Nenndrücke PN beziehen sich auf die Stahl- und Edelstahlversion der Verschraubung.
Für Messingverschraubungen sind diese Drücke um 35% zu reduzieren.

WMTX Gerader Schottstutzen

Triple-Lok® 37° Bördelanschluss
SAE 070601 MS51520

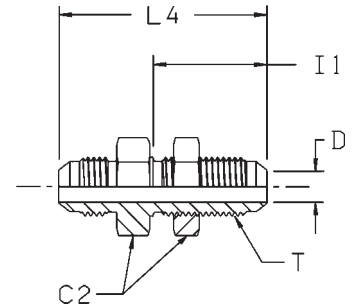

Rohr A.D.		Gewinde UN/UNF-2A T	C2 mm	D mm	I1 mm	L4 mm	Gewicht (Stahl) g/1 St.	Triple-Lok® Stahl	Triple-Lok® Edelstahl	Triple-Lok® Messing	PN (bar)	
mm	Zoll										S	SS
6	1/4	7/16-20	17	4	31	53	41	4WMTXWLNMS	4WMTXWLNMS	4WMTXWLNMB	500	350
8	5/16	1/2-20	19	6	31	53	49	5WMTXWLNMS	5WMTXWLNMS	5WMTXWLNMB	420	350
10	3/8	9/16-18	22	8	33	55	64	6WMTXWLNMS	6WMTXWLNMS	6WMTXWLNMB	420	350
12	1/2	3/4-16	24	10	37	62	111	8WMTXWLNMS	8WMTXWLNMS	8WMTXWLNMB	420	350
14, 15, 16	5/8	7/8-14	30	12	40	70	157	10WMTXWLNMS	10WMTXWLNMS	10WMTXWLNMB	350	350
18, 20	3/4	1 1/16-12	36	16	44	79	254	12WMTXWLNMS	12WMTXWLNMS	12WMTXWLNMB	350	350
22	7/8	1 3/16-12	38	18	45	80	296	14 WTX-WLN-S	14WMTXWLNMS	14WMTXWLNMB	280	280
25	1	1 5/16-12	41	22	44	80	337	16WMTXWLNMS	16WMTXWLNMS	16WMTXWLNMB	280	280
28, 30, 32	1 1/4	1 5/8-12	50	28	46	84	462	20WMTXWLNMS	20WMTXWLNMS	20WMTXWLNMB	280	210
35, 38	1 1/2	1 7/8-12	55	33	46	89	695	24WMTXWLNMS	24WMTXWLNMS	24WMTXWLNMB	210	140

Die angegebenen Artikel entsprechen unserem Standard-Lieferprogramm.
Zöllige und metrische Versionen können sich in der Schlüsselweite unterscheiden.

Für die Version ohne Gegenmutter „WLNMS“ weglassen (z. B. 16WMTX)

$$\frac{\text{PN (bar)}}{10} = \text{PN (MPa)}$$

Die angegebenen Nenndrücke PN beziehen sich auf die Stahl- und Edelstahlversion der Verschraubung.
Für Messingverschraubungen sind diese Drücke um 35% zu reduzieren.

Maximale Schottwandstärke

Größe	Rohr A.D.		Gerade Schottverschraubung Max. Wandstärke mm	Form Schottverschraubung Max. Wandstärke mm
	Zoll	Metrisch		
4	1/4	6	8,4	5,3
5	5/16	8	8,4	5,3
6	3/8	10	10,7	7,1
8	1/2	12	11,2	8,4
10	5/8	14–16	10,9	8,1
12	3/4	18–20	11,2	8,6
14	7/8		10,4	7,9
16	1	22–25	9,9	7,4
20	1 1/4	28–32	10,2	7,4
24	1 1/2	35–38	7,1	—
32	2		7,1	—

WEMTX Winkelschottstutzen

Triple-Lok® 37° Bördelanschluss
SAE 070701 MS51507

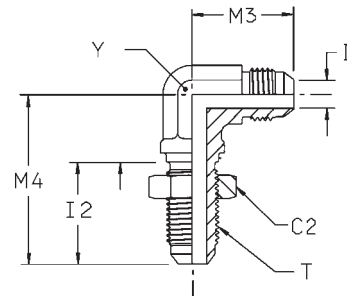

Rohr A.D.		Gewinde UN/UNF-2A T	C2 mm	D mm	I2 mm	M3 mm	M4 mm	Y mm	Gewicht (Stahl) g/1 St.	Triple-Lok® Stahl	Triple-Lok® Edelstahl	Triple-Lok® Messing	PN (bar)	
mm	Zoll												S	SS
6	1/4	7/16-20	17	4	26	25	40	11	44	4WEMTXWLNMS	4 WETX-WLN-SS	4 WETX-WLN-B	500	350
8	5/16	1/2-20	19	6	26	27	44	13	59	5WEMTXWLNMS	5 WETX-WLN-SS	5 WETX-WLN-B	420	350
10	3/8	9/16-18	22	8	28	28	46	14	72	6WEMTXWLNMS	6 WETX-WLN-SS	6 WETX-WLN-B	420	350
12	1/2	3/4-16	24	10	32	36	54	19	145	8WEMTXWLNMS	8 WETX-WLN-SS	8 WETX-WLN-B	420	350
14, 15, 16	5/8	7/8-14	30	12	35	40	61	22	212	10WEMTXWLNMS	10 WETX-WLN-SS	10 WETX-WLN-B	350	350
18, 20	3/4	1 1/16-12	36	16	40	45	68	27	345	12WEMTXWLNMS	12 WETX-WLN-SS	12 WETX-WLN-B	350	350
22	7/8	1 3/16-12	38	18	40	49	71	41	370	14 WETX-WLN-S	14 WETX-WLN-SS		280	—
25	1	1 5/16-12	41	22	40	49	71	41	474	16 WETX-WLN-S	16 WETX-WLN-SS		280	—
28, 30, 32	1 1/4	1 5/8-12	48	28	41	55	80	41	753	20 WETX-WLN-S	20 WETX-WLN-SS		280	—

Die angegebenen Artikel entsprechen unserem Standard-Lieferprogramm.
Zöllige und metrische Versionen können sich in der Schlüsselweite unterscheiden.

Für die Version ohne Gegenmutter „WLNMS“ weglassen (z. B. 16WMTX)

$$\frac{\text{PN (bar)}}{10} = \text{PN (MPa)}$$

Die angegebenen Nenndrücke PN beziehen sich auf die Stahl- und Edelstahlversion der Verschraubung.
Für Messingverschraubungen sind diese Drücke um 35% zu reduzieren.

Maximale Schottwandstärke

Größe	Rohr A.D.		Gerade Schottverschraubung Max. Wandstärke mm	Form Schottverschraubung Max. Wandstärke mm
	Zoll	Metrisch		
4	1/4	6	8,4	5,3
5	5/16	8	8,4	5,3
6	3/8	10	10,7	7,1
8	1/2	12	11,2	8,4
10	5/8	14–16	10,9	8,1
12	3/4	18–20	11,2	8,6
14	7/8		10,4	7,9
16	1	22–25	9,9	7,4
20	1 1/4	28–32	10,2	7,4
24	1 1/2	35–38	7,1	—
32	2		7,1	—

WNTX 45° Winkelschottstutzen

Triple-Lok® 37° Bördelanschluss
SAE 070801 MS51509

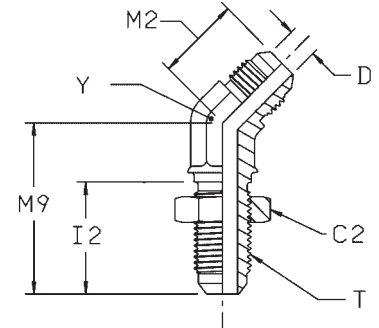

Rohr A.D.		Gewinde UN/UNF-2A T	C2 mm	D mm	I2 mm	M2 mm	M9 mm	Y mm	Gewicht (Stahl) g/1 St.	Triple-Lok® Stahl	Triple-Lok® Edelstahl	PN (bar)	
mm	Zoll											S	SS
6	1/4	7/16-20	17	4	26	18	39	11	32	4 WNTX-WLN-S	4 WNTX-WLN-SS	500	350
8	5/16	1/2-20	19	6	26	20	42	14	41	5 WNTX-WLN-S	5 WNTX-WLN-SS	420	—
10	3/8	9/16-18	21	8	28	21	42	14	48	6 WNTX-WLN-S	6 WNTX-WLN-SS	420	350
12	1/2	3/4-16	25	10	32	25	49	19	105	8 WNTX-WLN-S	8 WNTX-WLN-SS	420	350
14, 15, 16	5/8	7/8-14	29	12	35	28	55	22	152	10 WNTX-WLN-S	10 WNTX-WLN-SS	350	350
18, 20	3/4	1 1/16-12	35	16	40	33	62	27	245	12 WNTX-WLN-S	12 WNTX-WLN-SS	350	350
22, 25	1	1 5/16-12	41	22	40	37	65	33	355	16 WNTX-WLN-S	16 WNTX-WLN-SS	280	280
28, 30, 32	1 1/4	1 5/8-12	48	28	41	40	67	41	465	20 WNTX-WLN-S	20 WNTX-WLN-SS	280	—

Die angegebenen Artikel entsprechen unserem Standard-Lieferprogramm.
Zöllige und metrische Versionen können sich in der Schlüsselweite unterscheiden.

Für die Version ohne Gegenmutter „WLN“ weglassen (z. B. 16WNTX)

$$\frac{\text{PN (bar)}}{10} = \text{PN (MPa)}$$

Die angegebenen Nenndrücke PN beziehen sich auf die Stahl- und Edelstahlversion der Verschraubung.

Maximale Schottwandstärke

Größe	Rohr A.D.		Gerade Schottverschraubung Max. Wandstärke mm	Form Schottverschraubung Max. Wandstärke mm
	Zoll	Metrisch		
4	1/4	6	8,4	5,3
5	5/16	8	8,4	5,3
6	3/8	10	10,7	7,1
8	1/2	12	11,2	8,4
10	5/8	14–16	10,9	8,1
12	3/4	18–20	11,2	8,6
14	7/8		10,4	7,9
16	1	22–25	9,9	7,4
20	1 1/4	28–32	10,2	7,4
24	1 1/2	35–38	7,1	—
32	2		7,1	—

WJTX T-Schottstutzen

Triple-Lok® 37° Bördelanschluss
SAE 070959 MS51515

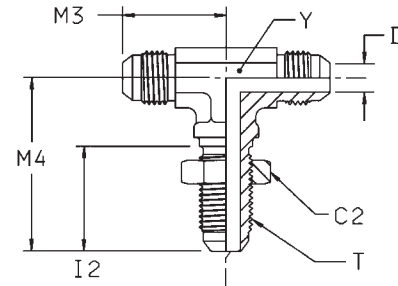

Rohr A.D.		Gewinde UN/UNF-2A T	C2 mm	D mm	I2 mm	M3 mm	M4 mm	Y mm	Gewicht (Stahl) g/1 St.	Triple-Lok® Stahl	Triple-Lok® Edelstahl	PN (bar)	
mm	Zoll											S	SS
6	1/4	7/16-20	17	4	26	25	40	11	45	4 WJTX-WLN-S	4 WJTX-WLN-SS	500	350
10	3/8	9/16-18	21	8	28	28	46	14	71	6 WJTX-WLN-S	6 WJTX-WLN-SS	420	350
12	1/2	3/4-16	25	10	32	35	54	19	158	8 WJTX-WLN-S	8 WJTX-WLN-SS	420	350
14, 15, 16	5/8	7/8-14	29	12	35	40	61	22	297	10 WJTX-WLN-S	10 WJTX-WLN-SS	350	350
18, 20	3/4	1 1/16-12	35	16	40	45	68	27	379	12 WJTX-WLN-S	12 WJTX-WLN-SS	350	350
22, 25	1	1 5/16-12	42	22	40	49	71	33	420	16 WJTX-WLN-S		280	—
28, 30, 32	1 1/4	1 5/8-12	48	28	41	55	79	41	500	20 WJTX-WLN-S		280	—

Die angegebenen Artikel entsprechen unsererem Standard-Lieferprogramm.
Zöllige und metrische Versionen können sich in der Schlüsselweite unterscheiden.

Für die Version ohne Gegenmutter „WLN“ weglassen (z.B. 16 WJTX)

$$\frac{\text{PN (bar)}}{10} = \text{PN (MPa)}$$

Die angegebenen Nenndrücke PN beziehen sich auf die Stahl- und Edelstahlversion der Verschraubung.

Maximale Schottwandstärke

Größe	Rohr A.D.		Gerade Schottverschraubung Max. Wandstärke mm	Form Schottverschraubung Max. Wandstärke mm
	Zoll	Metrisch		
4	1/4	6	8,4	5,3
5	5/16	8	8,4	5,3
6	3/8	10	10,7	7,1
8	1/2	12	11,2	8,4
10	5/8	14–16	10,9	8,1
12	3/4	18–20	11,2	8,6
14	7/8		10,4	7,9
16	1	22–25	9,9	7,4
20	1 1/4	28–32	10,2	7,4
24	1 1/2	35–38	7,1	—
32	2		7,1	—

WJJTX L-Schottstutzen

Triple-Lok® 37° Bördelanschluss
SAE 070958 MS51516

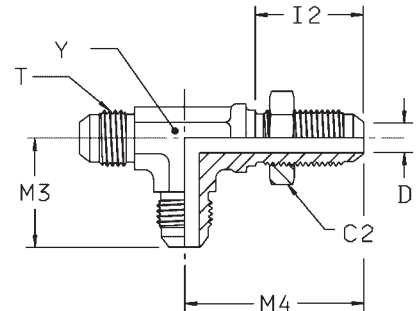

Rohr A.D.		Gewinde UN/UNF-2A T	C2 mm	D mm	I2 mm	M3 mm	M4 mm	Y mm	Gewicht (Stahl) g/1 St.	Triple-Lok® Stahl	PN (bar)
mm	Zoll										
6	1/4	7/16-20	17	4	26	25	40	11	58	4 WJJTX-WLN-S	500
10	3/8	9/16-18	21	8	28	28	46	14	75	6 WJJTX-WLN-S	420
12	1/2	3/4-16	25	10	32	35	54	19	158	8 WJJTX-WLN-S	420
14, 15, 16	5/8	7/8-14	29	12	35	40	61	22	309	10 WJJTX-WLN-S	350
18, 20	3/4	1 1/16-12	35	16	40	45	68	27	340	12 WJJTX-WLN-S	350
22, 25	1	1 5/16-12	42	22	40	49	71	36	390	16 WJJTX-WLN-S	280
28, 30, 32	1 1/4	1 5/8-12	48	28	41	55	79	41	450	20 WJJTX-WLN-S	280

Die angegebenen Artikel entsprechen unserem Standard-Lieferprogramm.
Zöllige und metrische Versionen können sich in der Schlüsselweite unterscheiden.

Für die Version ohne Gegenmutter „WLN“ weglassen (z.B. 16 WJJTX)

$$\frac{\text{PN (bar)}}{10} = \text{PN (MPa)}$$

Maximale Schottwandstärke

Größe	Rohr A.D.		Gerade Schottverschraubung Max. Wandstärke mm	Form Schottverschraubung Max. Wandstärke mm
	Zoll	Metrisch		
4	1/4	6	8,4	5,3
5	5/16	8	8,4	5,3
6	3/8	10	10,7	7,1
8	1/2	12	11,2	8,4
10	5/8	14–16	10,9	8,1
12	3/4	18–20	11,2	8,6
14	7/8		10,4	7,9
16	1	22–25	9,9	7,4
20	1 1/4	28–32	10,2	7,4
24	1 1/2	35–38	7,1	—
32	2		7,1	—

C6MX Winkelstutzen

Triple-Lok® 37° Bördelanschluss / Triple-Lok® 37° Swivel, einstellbar
SAE 070221 MS51521

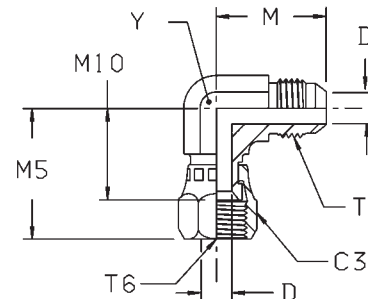

Rohr A.D.	Zoll	Gewinde UN/UNF-2A T	Gewinde UN/UNF-2B T6	C3 mm	D mm	M mm	M5 mm	M10 mm	Y mm	Gewicht (Stahl) g/1 St.	Triple-Lok® Stahl	Triple-Lok® Edelstahl	PN (bar)	
													S	SS
6	3/16	3/8-24	3/8-24	13	3	21	25	16	11	27	3 C6X-S		500	—
8	1/4	7/16-20	7/16-20	16	4	23	25	17	11	37	4C6MXS	4C6MXSS	500	350
10	5/16	1/2-20	1/2-20	17	6	24	27	17	13	43	5C6MXS	5C6MXSS	420	350
12	3/8	9/16-18	9/16-18	19	8	27	32	22	14	54	6C6MXS	6C6MXSS	350	350
	1/2	3/4-16	3/4-16	22	10	32	35	24	19	105	8C6MXS	8C6MXSS	350	350
14, 15, 16	5/8	7/8-14	7/8-14	27	12	37	41	28	22	162	10C6MXS	10C6MXSS	350	350
18, 20	3/4	1 1/16-12	1 1/16-12	32	16	42	44	30	27	260	12C6MXS	12C6MXSS	350	350
22	7/8	1 3/16-12	1 3/16-12	35	18	46	45	34	33	293	14 C6X-S		250	—
25	1	1 5/16-12	1 5/16-12	38	22	46	51	36	33	420	16C6MXS	16C6MXSS	250	250
28, 30, 32	1 1/4	1 5/8-12	1 5/8-12	50	28	52	59	43	41	679	20C6MXS	20C6MXSS	250	210
35, 38	1 1/2	1 7/8-12	1 7/8-12	57	33	59	66	47	48	747	24 C6X-S	24C6MXSS	170	140
	2	2 1/2-12	2 1/2-12	73	45	78	89	62	66	920	32 C6X-S		110	—

Die angegebenen Artikel entsprechen unserem Standard-Lieferprogramm.
Zöllige und metrische Versionen können sich in der Schlüsselweite unterscheiden.

$$\frac{\text{PN (bar)}}{10} = \text{PN (MPa)}$$

Die angegebenen Nenndrücke PN beziehen sich auf die Stahl- und Edelstahlversion der Verschraubung.

V6MX 45° Winkelstutzen

Triple-Lok® 37° Bördelanschluss / Triple-Lok® 37° Swivel, einstellbar
SAE 070321 MS51522

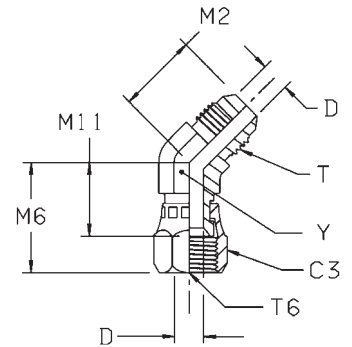

Rohr A.D.		Gewinde UN/UNF-2A T	Gewinde UN/UNF-2B T6	C3 mm	D mm	M2 mm	M6 mm	M11 mm	Y mm	Gewicht (Stahl) g/1 St.	Triple-Lok® Stahl	Triple-Lok® Edelstahl	PN (bar)	
mm	Zoll												S	SS
6	1/4	7/16-20	7/16-20	14	4	18	24	15	11	30	4 V6X-S	4 V6X-SS	500	350
8	5/16	1/2-20	1/2-20	16	6	20	25	16	14	45	5 V6X-S	5 V6X-SS	420	350
10	3/8	9/16-18	9/16-18	19	8	21	28	19	14	47	6V6MXS	6 V6X-SS	350	350
12	1/2	3/4-16	3/4-16	22	10	25	33	22	19	89	8V6MXS	8 V6X-SS	350	350
14, 15, 16	5/8	7/8-14	7/8-14	27	12	28	37	24	22	131	10V6MXS	10 V6X-SS	350	350
18, 20	3/4	1 1/16-12	1 1/16-12	32	16	33	38	24	27	203	12V6MXS	12 V6X-SS	350	350
22	7/8	1 3/16-12	1 3/16-12	35	18	35	41	28	30	291	14 V6X-S		250	—
25	1	1 5/16-12	1 5/16-12	38	22	37	44	29	33	335	16V6MXS	16 V6X-SS	250	250
28, 30, 32	1 1/4	1 5/8-12	1 5/8-12	51	27	40	52	36	41	572	20 V6X-S	20 V6X-SS	250	210
35, 38	1 1/2	1 7/8-12	1 7/8-12	57	33	45	58	39	48	715	24 V6X-S	24 V6X-SS	170	140
	2	2 1/2-12	2 1/2-12	72	45	56	70	50	66	960	32 V6X-S	32 V6X-SS	110	110

Die angegebenen Artikel entsprechen unserem Standard-Lieferprogramm.
Zöllige und metrische Versionen können sich in der Schlüsselweite unterscheiden.

$$\frac{\text{PN (bar)}}{10} = \text{PN (MPa)}$$

Die angegebenen Nenndrücke PN beziehen sich auf die Stahl- und Edelstahlversion der Verschraubung.

K

S6MX T-Stutzen

Triple-Lok® 37° Bördelanschluss / Triple-Lok® 37° Swivel, einstellbar
SAE 070433 MS51524

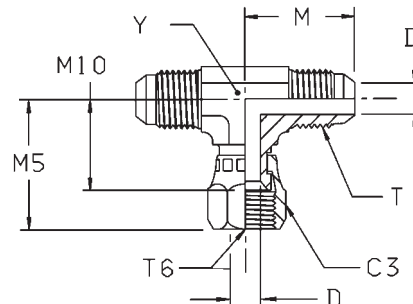

Rohr A.D.		Gewinde UN/UNF-2A T	Gewinde UN/UNF-2B T6	C3 mm	D mm	M mm	M5 mm	M10 mm	Y mm	Gewicht (Stahl) g/1 St.	Triple-Lok® Stahl	Triple-Lok® Edelstahl	PN (bar)	
mm	Zoll												S	SS
6	1/4	7/16-20	7/16-20	16	4	23	25	17	11	44	4S6MXS	4 S6X-SS	500	350
8	5/16	1/2-20	1/2-20	17	6	24	27	17	13	58	5S6MXS	5 S6X-SS	420	350
10	3/8	9/16-18	9/16-18	19	8	27	32	22	14	71	6S6MXS	6 S6X-SS	350	350
12	1/2	3/4-16	3/4-16	22	10	32	35	24	19	133	8S6MXS	8 S6X-SS	350	350
14, 15, 16	5/8	7/8-14	7/8-14	27	12	37	41	28	22	203	10S6MXS	10 S6X-SS	350	350
18, 20	3/4	1 1/16-12	1 1/16-12	32	16	42	44	30	27	328	12S6MXS	12 S6X-SS	350	350
25	1	1 5/16-12	1 5/16-12	38	22	46	51	36	33	483	16S6MXS	16 S6X-SS	250	250
28, 30, 32	1 1/4	1 5/8-12	1 5/8-12	50	28	52	59	43	41	708	20 S6X-S	20 S6X-SS	250	210
35, 38	1 1/2	1 7/8-12	1 7/8-12	57	33	59	68	49	48	1100	24 S6X-S	24 S6X-SS	170	170

Die angegebenen Artikel entsprechen unsererem Standard-Lieferprogramm.
Zöllige und metrische Versionen können sich in der Schlüsselweite unterscheiden.

$$\frac{\text{PN (bar)}}{10} = \text{PN (MPa)}$$

Die angegebenen Nenndrücke PN beziehen sich auf die Stahl- und Edelstahlversion der Verschraubung.

R6MX L-Stutzen

Triple-Lok® 37° Bördelanschluss / Triple-Lok® 37° Swivel, einstellbar
SAE 070432

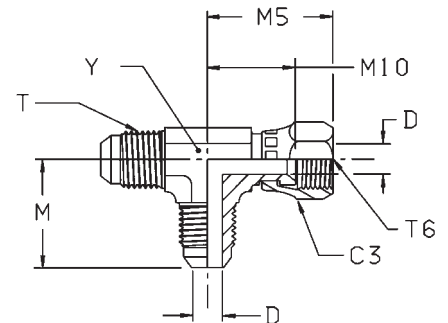

Rohr A.D.		Gewinde UN/UNF-2A T	Gewinde UN/UNF-2B T6	C3 mm	D mm	M mm	M5 mm	M10 mm	Y mm	Gewicht (Stahl) g/1 St.	Triple-Lok® Stahl	Triple-Lok® Edelstahl	PN (bar)	
mm	Zoll												S	SS
6	1/4	7/16-20	7/16-20	16	4	23	25	17	11	44	4R6MXS	4 R6X-SS	500	350
8	5/16	1/2-20	1/2-20	17	6	24	27	17	13	56	5R6MXS	5 R6X-SS	420	350
10	3/8	9/16-18	9/16-18	19	8	27	32	22	14	69	6R6MXS	6 R6X-SS	350	350
12	1/2	3/4-16	3/4-16	22	10	32	35	24	19	136	8R6MXS	8 R6X-SS	350	350
14, 15, 16	5/8	7/8-14	7/8-14	27	12	37	41	28	22	207	10R6MXS	10 R6X-SS	350	350
18, 20	3/4	1 1/16-12	1 1/16-12	32	16	42	44	30	27	319	12R6MXS	12 R6X-SS	350	350
22	7/8	1 3/16-12	1 3/16-12	35	18	46	45	34	33	622	14 R6X-S	14 R6X-SS	250	250
25	1	1 5/16-12	1 5/16-12	38	22	46	51	36	33	489	16R6MXS	16 R6X-SS	250	250
28, 30, 32	1 1/4	1 5/8-12	1 5/8-12	50	28	52	59	43	41	712	20R6MXS	20 R6X-SS	250	210
35, 38	1 1/2	1 7/8-12	1 7/8-12	57	33	59	66	47	48	1100	24 R6X-S	24 R6X-SS	170	170

Die angegebenen Artikel entsprechen unserem Standard-Lieferprogramm.
Zöllige und metrische Versionen können sich in der Schlüsselweite unterscheiden.

$$\frac{\text{PN (bar)}}{10} = \text{PN (MPa)}$$

Die angegebenen Nenndrücke PN beziehen sich auf die Stahl- und Edelstahlversion der Verschraubung.



BBMTX Gerader Aufschraubadapter

Triple-Lok® 37° Innengewinde / Triple-Lok® 37° Swivel, einstellbar

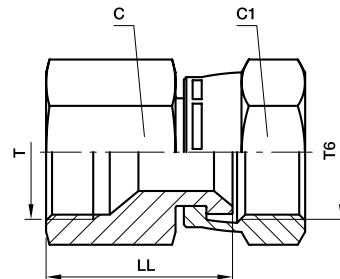

Rohr A.D.		Gewinde UN/UNF-2A T	Gewinde UN/UNF-2B T6	C mm	C1 mm	LL mm	Gewicht (Stahl) g/1 St.	Triple-Lok® Stahl	Triple-Lok® Edelstahl	PN (bar)	
mm	Zoll									S	SS
6	1/4	7/16-20	7/16-20	14	16	23	25	4BBMTXS	4BBMTXSS	500	350
8	5/16	1/2-20	1/2-20	17	17	26	32	5BBMTXS	5BBMTXSS	420	350
10	3/8	9/16-20	9/16-20	19	19	26	60	6BBMTXS	6BBMTXSS	350	350
12	1/2	3/4-16	3/4-16	22	22	32	87	8BBMTXS	8BBMTXSS	350	350
14, 15, 16	5/8	7/8-14	7/8-14	27	27	36	150	10BBMTXS	10BBMTXSS	350	350
18, 20	3/4	1 1/16-12	1 1/16-12	32	32	37	221	12BBMTXS	12BBMTXSS	350	350
25	1	1 5/16-12	1 5/16-12	41	38	42	348	16BBMTXS	16BBMTXSS	250	250
28, 30, 32	1 1/4	1 5/8-12	1 5/8-12	50	50	47	955	20BBMTXS	20BBMTXSS	250	210
35, 38	1 1/2	1 7/8-12	1 7/8-12	60	60	54	1031	24BBMTXS	24BBMTXSS	170	140

Die angegebenen Artikel entsprechen unserem Standard-Lieferprogramm.
Zöllige und metrische Versionen können sich in der Schlüsselweite unterscheiden.

$$\frac{\text{PN (bar)}}{10} = \text{PN (MPa)}$$

Die angegebenen Nenndrücke PN beziehen sich auf die Stahl- und Edelstahlversion der Verschraubung.

TRMTX Reduzierstutzen

Triple-Lok® 37° Bördelanschluss / Triple-Lok® 37° Swivel*, einstellbar
SAE 070123 MS51534

*Form A einteilig

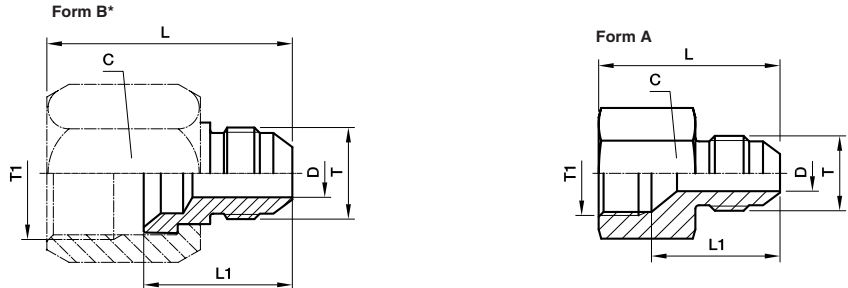

* Für Form B ist eine BTX- oder
BTMX-Überwurfmutter erforderlich
(bitte gesondert bestellen)

Rohr Metrisch T1 A.D.	Rohr Metrisch T A.D.	Rohr Zoll T1 A.D.	Rohr Zoll T A.D.	Gewinde UN/UNF-2B T1	Gewinde UN/UNF-2A T	Form	C mm	D mm	L mm	L1 mm	Gewicht (Stahl) g/1 St.	Triple-Lok® Stahl	Triple-Lok® Edelstahl	Triple-Lok® Messing	PN (bar) S SS
8	6	1/4	1/8	7/16-20	5/16-24	B	14	2	31	19	16	4-2TRTXS	4-2TRMTXSS		500 350
10	6	5/16	1/4	1/2-20	7/16-20	A	17	4	27	24	21	5-4TRMTXS	5-4TRMTXSS		420 350
10	8	3/8	1/4	9/16-18	7/16-20	B	19	4	36	23	35	6-4TRTXS	6-4TRMTXSS	6-4 TRTX-B	420 350
10	8	3/8	5/16	9/16-18	1/2-20	A	19	6	29	26	29	6-5TRMTXS	6-5TRMTXSS		420 350
12	6	1/2	1/4	3/4-16	7/16-20	B	22	4	38	23	38	8-4TRTXS	8-4TRMTXSS	8-4 TRTX-B	420 350
12	8	1/2	5/16	3/4-16	1/2-20	B	22	6	38	23	35	8-5TRTXS	8-5TRMTXSS		420 350
12	10	1/2	3/8	3/4-16	9/16-20	B	22	8	38	23	32	8-6TRTXS	8-6TRMTXSS	8-6 TRTX-B	420 350
14, 15, 16	6	5/8	1/4	7/8-14	7/16-20	B	27	4	45	26	83	10-4TRTXS	10-4TRMTXSS		350 350
14, 15, 16	8	5/8	5/16	7/8-14	1/2-20	B	27	6	41	26	80	10-5TRTXS	10-5TRMTXSS		350 350
14, 15, 16	10	5/8	3/8	7/8-14	9/16-20	B	27	8	41	29	78	10-6TRTXS	10-6TRMTXSS	10-6 TRTX-B	350 350
14, 15, 16	12	5/8	1/2	7/8-14	3/4-16	A	27	10	37	22	73	10-8TRMTXS	10-8TRMTXSS		350 350
18, 20	6	3/4	1/4	1 1/16-12	7/16-20	B	32	4	47	28	120	12-4TRTXS	12-4TRMTXSS	12-4 TRTX-B	350 350
18, 20	8	3/4	5/16	1 1/16-12	1/2-20	B	32	6	45	26	118	12-5TRTXS	12-5TRMTXSS		350 350
18, 20	10	3/4	3/8	1 1/16-12	9/16-20	B	32	8	47	25	115	12-6TRTXS	12-6TRMTXSS	12-6 TRTX-B	350 350
18, 20	12	3/4	1/2	1 1/16-12	3/4-16	B	32	10	50	27	128	12-8TRTXS	12-8TRMTXSS	12-8 TRTX-B	350 350
18, 20	14, 15, 16	3/4	5/8	1 1/16-12	7/8-14	A	32	12	42	26	119	12-10TRMTXS	12-10TRMTXSS		350 350
22	10	7/8	3/8	1 3/16-12	9/16-20	B	35	8	50	29	102	14-6TRTXS	14-6TRMTXSS		350 350
22	14, 15, 16	7/8	5/8	1 3/16-12	7/8-14	B	35	12	55	34	120	14-10TRTXS	14-10TRMTXSS		350 350
22	18, 20	7/8	3/4	1 3/16-12	1 1/16-12	A	35	16	47	33	166	14-12 TRTXN-S	14-12TRMTXSS		350 350
25	6	1	1/4	7/16-20	1 5/16-12	B	41	4	53	31	205	16-4TRTXS	16-4TRMTXSS		310 350
25	10	1	3/8	9/16-18	1 5/16-12	B	41	8	48	31	215	16-6TRTXS	16-6TRMTXSS		310 350
25	12	1	1/2	1 5/16-12	3/4-16	B	41	10	49	29	228	16-8TRTXS	16-8TRMTXSS		310 350
25	14, 15, 16	1	5/8	1 5/16-12	7/8-14	B	41	12	52	30	239	16-10TRTXS	16-10TRMTXSS		310 350
25	18, 20	1	3/4	1 5/16-12	1 1/16-12	B	41	16	55	35	252	16-12TRTXS	16-12TRMTXSS		310 280
25	22	1	7/8	1 5/16-12	1 3/16-12	A	38	18	60	38	224	16-14 TRTXN-S	16-14TRMTXSS		310 280
28, 30, 32	14, 15, 16	1 1/4	5/8	1 5/8-12	7/8-14	B	50	12	59	32	380	20-10TRTXS	20-10TRMTXSS		280 280
28, 30, 32	18, 20	1 1/4	3/4	1 5/8-12	1 1/16-12	B	50	16	62	39	370	20-12TRTXS	20-12TRMTXSS		280 280
28, 30, 32	25	1 1/4	1	1 5/8-12	1 5/16-12	B	50	21	64	40	355	20-16TRTXS	20-16TRMTXSS		280 280
35, 38	20	1 1/2	3/4	1 1/16-12	1 7/8-12	B	60	16	63	41	520	24-12TRTXS	24-12TRMTXSS		210 280
35, 38	25	1 1/2	1	1 5/16-12	1 7/8-12	B	60	22	63	41	570	24-16TRTXS	24-16TRMTXSS		210 140
35, 38	28, 30, 32	1 1/2	1 1/4	1 7/8-12	1 5/8-12	B	60	27	70	43	614	24-20TRTXS	24-20TRMTXSS		210 140
42	35, 38			2 1/4-12	1 7/8-12	B	65	33	72	42	839	28-24TRTXS	28-24TRMTXSS		140 140
50	38	2	1 1/2	1 7/8-12	2 1/2-12	B	70	34	75	49	900	32-24TRTXS			140 —

Die angegebenen Artikel entsprechen unserem Standard-Lieferprogramm.
Zöllige und metrische Versionen können sich in der Schlüsselweite unterscheiden.

$$\frac{\text{PN (bar)}}{10} = \text{PN (MPa)}$$

Die angegebenen Nenndrücke PN beziehen sich auf die Stahl- und Edelstahlversion der Verschraubung.
Für Messingverschraubungen sind diese Drücke um 35% zu reduzieren.



HMX6 Gerader Stutzen

Triple-Lok® 37° Swivel, einstellbar

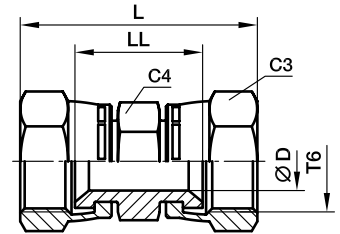

Rohr A.D.		Gewinde UN/UNF-2B T6	C3 mm	C4 mm	D mm	L mm	LL mm	Gewicht (Stahl) g/1 St.	Triple-Lok® Stahl	Triple-Lok® Edelstahl	PN (bar)	
mm	Zoll										S	SS
6	1/4	7/16-20	14	14	5	38	20	27	4 HX6-S	4HMX6SS	500	500
8, 10	5/16, 3/8	9/16-18	18	18	8	45	26	35	6 HX6-S	6HMX6SS	350	350
12	1/2	3/4-16	22	22	10	51	30	64	8 HX6-S	8HMX6SS	350	350
14, 15, 16	5/8	7/8-14	25	25	13	57	32	115	10 HX6-S	10HMX6SS	350	350
18, 20	3/4	1 1/16-12	32	32	16	62	33	185	12 HX6-S	12HMX6SS	350	350
25	1	1 5/16-12	41	41	22	68	38	235	16 HX6-S	16HMX6SS	250	250

Die angegebenen Artikel entsprechen unserem Standard-Lieferprogramm.
Zöllige und metrische Versionen können sich in der Schlüsselweite unterscheiden.

$$\frac{\text{PN (bar)}}{10} = \text{PN (MPa)}$$

Die angegebenen Nenndrücke PN beziehen sich auf die Stahl- und Edelstahlversion der Verschraubung.

JX6 T-Stutzen

Triple-Lok® 37° Swivel, einstellbar

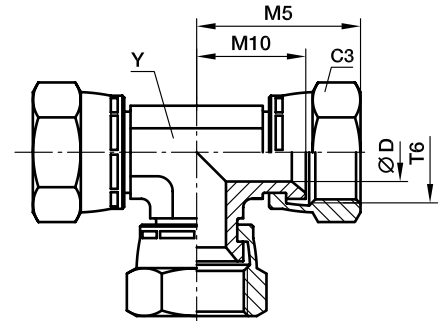

Rohr A.D.		Gewinde UN/UNF-2B T6	C3 mm	D mm	M5 mm	M10 mm	Y mm	Gewicht (Stahl) g/1 St.	Triple-Lok® Stahl	PN (bar)
mm	Zoll									
6	1/4	7/16-20	14	5	25	17	11	55	4 JX6-S	500
8, 10	5/16, 3/8	9/16-18	18	8	32	22	14	85	6 JX6-S	350
12	1/2	3/4-16	22	10	35	24	19	150	8 JX6-S	350
14, 15, 16	5/8	7/8-14	25	13	41	29	19	220	10 JX6-S	350
18, 20	3/4	1 1/16-12	32	16	45	30	27	345	12 JX6-S	350
25	1	1 5/16-12	41	22	51	36	30	510	16 JX6-S	250

Zöllige und metrische Versionen können sich in der Schlüsselweite unterscheiden.

$$\frac{\text{PN (bar)}}{10} = \text{PN (MPa)}$$

K

F87OMX Gerader Einschraubstutzen

Triple-Lok® 37° Bördelanschluss / Metr. Einschraubzapfen – O-Ring (ISO 6149)

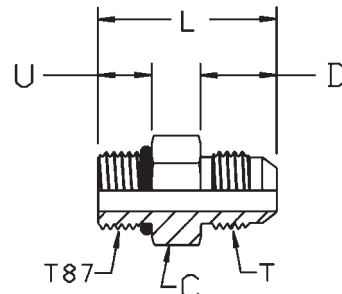

Rohr A.D. mm	Zoll	Gewinde Metrisch T87	Gewinde UN/UNF-2A T	L mm	D mm	C mm	U mm	Gewicht (Stahl) g/1 St.	Triple-Lok® Stahl	Triple-Lok® Edelstahl	PN (bar)	
											S	SS
6	1/4	M10 × 1,0	7/16-20	30	14	14	9	25	4M10F87OMXS	4M10F87OMXSS	500	350
8	5/16	M10 × 1,0	1/2-20	30	14	14	9	30	5M10F87OMXS	5M10F87OMXSS	420	350
8	5/16	M12 × 1,5	1/2-20	33	14	19	11	37	5M12F87OMXS	5M12F87OMXSS	420	350
8	5/16	M14 × 1,5	1/2-20	34	14	19	11	40	5M14F87OMXS	5M14F87OMXSS	420	350
10	3/8	M14 × 1,5	9/16-18	34	14	19	11	44	6M14F87OMXS	6M14F87OMXSS	420	350
10	3/8	M16 × 1,5	9/16-18	36	14	22	12	53	6M16F87OMXS	6M16F87OMXSS	420	350
10	3/8	M18 × 1,5	9/16-18	37	14	24	13	60	6M18F87OMXS	6M18F87OMXSS	350	350
12	1/2	M14 × 1,5	3/4-16	36	17	19	11	41	8M14F87OMXS	8M14F87OMXSS	420	350
12	1/2	M16 × 1,5	3/4-16	38	17	22	12	57	8M16F87OMXS	8M16F87OMXSS	420	350
12	1/2	M18 × 1,5	3/4-16	39	17	24	13	71	8M18F87OMXS	8M18F87OMXSS	350	350
14, 15, 16	5/8	M14 × 1,5	7/8-14	41	19	24	11	73	10M14F87OMXS	10M14F87OMXSS	350	350
14, 15, 16	5/8	M18 × 1,5	7/8-14	43	19	24	13	75	10M18F87OMXS	10M18F87OMXSS	350	350
14, 15, 16	5/8	M22 × 1,5	7/8-14	44	19	27	13	98	10M22F87OMXS	10M22F87OMXSS	350	350
14, 15, 16	5/8	M27 × 2,0	7/8-14	46	19	32	16	75	10M27F87OMXS	10M27F87OMXSS	350	350
18, 20	3/4	M22 × 1,5	1 1/16-12	48	22	27	13	104	12M22F87OMXS	12M22F87OMXSS	350	350
18, 20	3/4	M27 × 2,0	1 1/16-12	51	22	32	16	158	12M27F87OMXS	12M27F87OMXSS	350	350
25	1	M27 × 2,0	1 5/16-12	51	23	36	16	206	16M27F87OMXS	16M27F87OMXSS	280	280
25	1	M33 × 2,0	1 5/16-12	53	23	41	16	273	16M33F87OMXS	16M33F87OMXSS	280	280
28, 30, 32	1 1/4	M42 × 2,0	1 5/8-12	55	24	50	16	431	20M42F87OMXS	20M42F87OMXSS	280	210
35, 38	1 1/2	M48 × 2,0	1 7/8-12	59	28	55	18	564	24M48F87OMXS	24M48F87OMXSS	210	140

Triple-Lok® Verschraubungen werden standardmäßig mit NBR Dichtung geliefert. Für alternative Dichtungswerkstoffe siehe Seite K93

Die angegebenen Artikel entsprechen unserem Standard-Lieferprogramm.

Zöllige und metrische Versionen können sich in der Schlüsselweite unterscheiden.

$$\frac{\text{PN (bar)}}{10} = \text{PN (MPa)}$$

Die angegebenen Nenndrücke PN beziehen sich auf die Stahl- und Edelstahlversion der Verschraubung.

F5OMX Gerader Einschraubstutzen

Triple-Lok® 37° Bördelanschluss / UN/UNF Einschraubzapfen – O-Ring (ISO 11926)
SAE 070120 MS51525

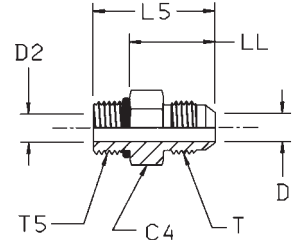

Rohr A.D.	Gewinde UN/UNF-2A T5	Gewinde UN/UNF-2A T	C4	D	D2	L5	LL	Gewicht (Stahl) g/1 St.	Triple-Lok® Stahl	Triple-Lok® Edelstahl	PN (bar)		
											mm	Zoll	S
6	1/8	5/16-24	5/16-24	11	2	2	27	19	8	2 F5OX-S	4F5OMXSS 4-3F5OMXSS	500	—
	3/16	3/8-24	3/8-24	13	3	3	28	20	10	3 F5OX-S		500	—
	3/16	5/16-24	3/8-24	13	3	2	28	20	9	3-2 F5OX-S		500	—
	1/4	7/16-20	7/16-20	14	4	4	31	22	15	4F5OMXS		500	350
	1/4	3/8-24	7/16-20	14	5	3	30	23	12	4-3 F5OX-S		500	350
	6	1/4	1/2-20	7/16-20	16	4	6	31	22	25		4-5 F5OX-S	4-5F5OMXSS
6	1/4	9/16-18	7/16-20	17	4	4	33	23	27	4-6F5OMXS	4-6F5OMXSS	420	350
6	1/4	3/4-16	7/16-20	22	4	10	35	24	35	4-8 F5OX-S	4-8F5OMXSS	420	350
6	1/4	7/8-14	7/16-20	25	5	5	38	25	60	4-10 F5OX-S	4-10F5OMXSS	350	350
8	5/16	1/2-20	1/2-20	16	6	6	31	22	18	5F5OMXS	5F5OMXSS	420	350
8	5/16	7/16-20	1/2-20	14	6	5	31	22	18	5-4 F5OX-S	5-4F5OMXSS	420	350
8	5/16	9/16-18	1/2-20	17	6	6	33	23	25	5-6 F5OX-S	5-6F5OMXSS	420	350
8	5/16	3/4-16	1/2-20	22	6	6	35	24	40	5-8 F5OX-S	5-8F5OMXSS	420	350
10	3/8	9/16-18	9/16-18	17	8	8	33	23	25	6F5OMXS	6F5OMXSS	420	350
10	3/8	7/16-20	9/16-18	16	8	4	32	23	40	6-4 F5OX-S	6-4F5OMXSS	420	350
10	3/8	1/2-20	9/16-18	16	8	6	32	23	56	6-5 F5OX-S	6-5F5OMXSS	420	350
10	3/8	3/4-16	9/16-18	22	8	8	35	24	44	6-8F5OMXS	6-8F5OMXSS	420	350
10	3/8	7/8-14	9/16-18	25	8	12	38	25	85	6-10 F5OX-S	6-10F5OMXSS	350	350
10	3/8	1 1/16-12	9/16-18	32	8	16	42	27	100	6-12 F5OX-S	6-12F5OMXSS	350	350
12	1/2	3/4-16	3/4-16	22	10	10	38	27	58	8F5OMXS	8F5OMXSS	420	350
12	1/2	7/16-20	3/4-16	21	10	5	38	29	40	8-4 F5OX-S	8-4F5OMXSS	420	350
12	1/2	9/16-18	3/4-16	19	10	10	37	27	44	8-6F5OMXS	8-6F5OMXSS	420	350
12	1/2	7/8-14	3/4-16	27	10	10	41	28	73	8-10F5OMXS	8-10F5OMXSS	350	350
12	1/2	1 1/16-12	3/4-16	32	10	10	45	30	126	8-12F5OMXS	8-12F5OMXSS	350	350
12	1/2	1 5/16-12	3/4-16	41	10	10	45	30	160	8-16 F5OX-S	8-16F5OMXSS	310	310
14, 15, 16	5/8	7/8-14	7/8-14	27	12	12	43	31	75	10F5OMXS	10F5OMXSS	350	350
14, 15, 16	5/8	9/16-18	7/8-14	18	13	8	43	34	60	10-6 F5OX-S	10-6F5OMXSS	350	350
14, 15, 16	5/8	3/4-16	7/8-14	24	12	10	42	31	65	10-8F5OMXS	10-8F5OMXSS	350	350
14, 15, 16	5/8	1 1/16-12	7/8-14	32	12	12	47	32	132	10-12F5OMXS	10-12F5OMXSS	350	350
14, 15, 16	5/8	1 5/16-12	7/8-14	41	13	13	48	33	170	10-16 F5OX-S	10-16F5OMXSS	310	310
18, 20	3/4	1 1/16-12	1 1/16-12	32	16	16	50	35	134	12F5OMXS	12F5OMXSS	350	350
18, 20	3/4	3/4-16	1 1/16-12	29	16	10	49	38	104	12-8 F5OX-S	12-8F5OMXSS	350	350
18, 20	3/4	7/8-14	1 1/16-12	27	16	12	48	35	108	12-10F5OMXS	12-10F5OMXSS	350	350
18, 20	3/4	1 3/16-12	1 1/16-12	35	16	16	50	35	170	12-14 F5OX-S	12-14F5OMXSS	310	310
18, 20	3/4	1 5/16-12	1 1/16-12	38	16	16	51	35	197	12-16F5OMXS	12-16F5OMXSS	310	310
18, 20	3/4	1 5/8-12	1 1/16-12	48	16	16	53	38	230	12-20 F5OX-S	12-20F5OMXSS	280	280
22	7/8	1 3/16-12	1 3/16-12	35	18	18	51	36	174	14 F5OX-S	14F5OMXSS	280	280
22	7/8	1 5/16-12	1 3/16-12	38	18	22	51	36	223	14-16 F5OX-S	14-16F5OMXSS	280	280
25	1	1 5/16-12	1 5/16-12	38	22	22	52	37	203	16F5OMXS	16F5OMXSS	280	280
25	1	3/4-16	1 5/16-12	35	22	10	45	34	160	16-8 F5OX-S	16-8F5OMXSS	280	280

Fortsetzung siehe Seite K30

F5OMX Gerader Einschraubstutzen

Triple-Lok® 37° Bördelanschluss / UN/UNF Einschraubzapfen – O-Ring (ISO 11926)
SAE 070120 MS51525

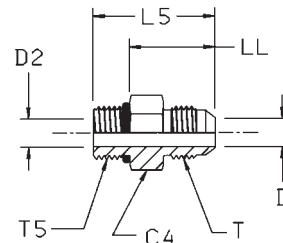

Rohr A.D.	Zoll	Gewinde UN/UNF-2A T5	Gewinde UN/UNF-2A T	C4 mm	D mm	D2 mm	L5 mm	LL mm	Gewicht (Stahl) g/1 St.	Triple-Lok® Stahl	Triple-Lok® Edelstahl	PN (bar)	
												S	SS
25	1	7/8-14	1 5/16-12	35	22	12	53	40	183	16-10 F5OX-S	16-10F5OMXSS	280	280
25	1	1 1/16-12	1 5/16-12	36	22	16	52	37	204	16-12F5OMXS	16-12F5OMXSS	280	280
25	1	1 3/16-12	1 5/16-12	35	22	18	52	37	198	16-14 F5OX-S	16-14F5OMXSS	280	280
25	1	1 5/8-12	1 5/16-12	48	22	28	54	39	270	16-20 F5OX-S	16-20F5OMXSS	280	280
25	1	1 7/8-12	1 5/16-12	55	22	22	56	41	310	16-24 F5OX-S	16-24F5OMXSS	210	210
28, 30, 32	1 1/4	1 5/8-12	1 5/8-12	50	28	28	55	40	274	20F5OMXS	20F5OMXSS	280	210
28, 30, 32	1 1/4	1 1/16-12	1 5/8-12	43	28	16	58	43	250	20-12 F5OX-S	20-12F5OMXSS	280	210
28, 30, 32	1 1/4	1 5/16-12	1 5/8-12	43	28	22	59	44	280	20-16 F5OX-S	20-16F5OMXSS	280	210
35, 38	1 1/2	1 7/8-12	1 7/8-12	55	33	33	60	45	355	24F5OMXS	24F5OMXSS	210	140
35, 38	1 1/2	1 5/8-12	1 7/8-12	51	33	28	64	49	340	24-20 F5OX-S	24-20F5OMXSS	210	140
35, 38	1 1/2	2 1/2-12	1 7/8-12	70	34	34	64	49	400	24-32 F5OX-S		140	—
	2	2 1/2-12	2 1/2-12	70	45	45	71	56	650	32 F5OX-S		140	—
	2	1 7/8-12	2 1/2-12	68	45	34	75	60	600	32-24 F5OX-S		140	—

Triple-Lok® Verschraubungen werden standardmäßig mit NBR Dichtung geliefert. Für alternative Dichtungswerkstoffe siehe Seite K93
Die angegebenen Artikel entsprechen unserem Standard-Lieferprogramm.
Zöllige und metrische Versionen können sich in der Schlüsselweite unterscheiden.

$$\frac{\text{PN (bar)}}{10} = \text{PN (MPa)}$$

Die angegebenen Nenndrücke PN beziehen sich auf die Stahl- und Edelstahlversion der Verschraubung.

FF5OMX Gerader Einschraubstutzen mit langem Schaft

Triple-Lok® 37° Bördelanschluss / UN/UNF Einschraubzapfen – O-Ring (ISO 11926)
SAE 070122 MS51526

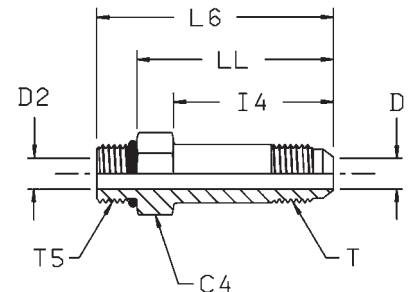

Rohr A.D.		Gewinde UN/UNF-2A T5	Gewinde UN/UNF-2A T	C4 mm	D mm	D2 mm	I4 mm	L6 mm	LL mm	Gewicht (Stahl) g/1 St.	Triple-Lok® Stahl	Triple-Lok® Edelstahl	PN (bar)	
mm	Zoll												S	SS
6	1/4	7/16-20	7/16-20	14	4	4	35	53	44	33	4 FF50X-S	4 FF50X-SS	500	500
10	3/8	9/16-18	9/16-18	17	8	8	40	59	49	53	6 FF50X-S	6 FF50X-SS	420	420
12	1/2	3/4-16	3/4-16	22	10	10	48	69	57	104	8 FF50X-S	8 FF50X-SS	420	420
14, 15, 16	5/8	7/8-14	7/8-14	25	12	12	53	77	64	151	10 FF50X-S	10 FF50X-SS	350	350
18, 20	3/4	1 1/16-12	1 1/16-12	32	16	16	64	92	77	277	12 FF50X-S	12 FF50X-SS	350	350
18, 20	3/4	7/8-14	1 1/16-12	27	16	12	64	89	76	236	12-10FF50MXS		350	—
25	1	1 5/16-12	1 5/16-12	38	21	21	72	101	86	458	16 FF50X-S	16 FF50X-SS	280	280
28, 30, 32	1 1/4	1 5/8-12	1 5/8-12	48	27	27	88	119	104	862	20 FF50X-S	20 FF50X-SS	280	280

Triple-Lok® Verschraubungen werden standardmäßig mit NBR Dichtung geliefert. Für alternative Dichtungswerkstoffe siehe Seite K93

Die angegebenen Artikel entsprechen unserem Standard-Lieferprogramm.

Zöllige und metrische Versionen können sich in der Schlüsselweite unterscheiden.

$$\frac{\text{PN (bar)}}{10} = \text{PN (MPa)}$$

Die angegebenen Nenndrücke PN beziehen sich auf die Stahl- und Edelstahlversion der Verschraubung.

K

F42EDMX Gerader Einschraubstutzen

Triple-Lok® 37° Bördelanschluss /
Zöll. Einschraubzapfen – ED (ISO 1179)

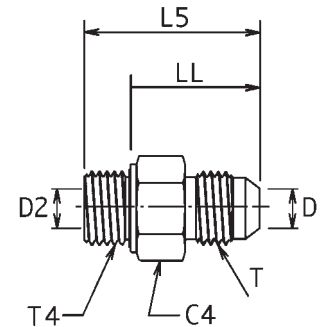

Rohr A.D. mm	Zoll	Gewinde BSP T4	Gewinde UN/UNF-2A T	C4 mm	D mm	D2 mm	L5 mm	LL mm	Gewicht (Stahl) g/1 St.	Triple-Lok® Stahl	Triple-Lok® Edelstahl	PN (bar)	
												S	SS
6	1/4	1/8-28	7/16-20	14	4	4	30	22	20	4F42EDMXS	4F42EDMXSS	500	350
6	1/4	1/4-19	7/16-20	19	4	4	35	23	34	4-4F42EDMXS	4-4F42EDMXSS	420	350
6	1/4	3/8-19	7/16-20	22	4	4	36	24	47	4-6F42EDMXS	4-6F42EDMXSS	420	350
6	1/4	1/2-14	7/16-20	27	4	4	39	25	99	4-8F42EDMXS	4-8F42EDMXSS	350	350
6	1/4	3/4-14	7/16-20	32	4	18	43	27	88	4-12F42EDMXS	4-12F42EDMXSS	350	350
8	5/16	1/8-28	1/2-20	14	6	4	30	22	20	5F42EDMXS	5F42EDMXSS	420	350
8	5/16	1/4-19	1/2-20	19	6	6	35	23	30	5-4F42EDMXS	5-4F42EDMXSS	420	350
8	5/16	3/8-19	1/2-20	22	6	6	36	24	47	5-6F42EDMXS	5-6F42EDMXSS	420	350
10	3/8	1/4-19	9/16-18	19	8	6	35	23	28	6F42EDMXS	6F42EDMXSS	420	350
10	3/8	1/8-28	9/16-18	16	8	4	31	23	27	6-2F42EDMXS	6-2F42EDMXSS	420	350
10	3/8	3/8-19	9/16-18	22	8	8	36	24	40	6-6F42EDMXS	6-6F42EDMXSS	420	350
10	3/8	1/2-14	9/16-18	27	8	8	40	25	95	6-8F42EDMXS	6-8F42EDMXSS	350	350
10	3/8	3/4-14	9/16-18	22	8	18	42	26	100	6-12F42EDMXS	6-12F42EDMXSS	350	350
12	1/2	3/8-19	3/4-16	22	10	10	39	27	50	8F42EDMXS	8F42EDMXSS	420	350
12	1/2	1/4-19	3/4-16	19	10	6	39	27	40	8-4F42EDMXS	8-4F42EDMXSS	420	350
12	1/2	1/2-14	3/4-16	27	10	10	42	28	100	8-8F42EDMXS	8-8F42EDMXSS	350	350
12	1/2	3/4-14	3/4-16	32	10	10	46	30	100	8-12F42EDMXS	8-12F42EDMXSS	350	350
12	1/2	1-11	3/4-16	41	10	23	53	35	150	8-16F42EDMXS	8-16F42EDMXSS	280	280
14, 15, 16	5/8	1/2-14	7/8-14	27	12	12	45	31	103	10F42EDMXS	10F42EDMXSS	350	350
14, 15, 16	5/8	1/4-19	7/8-14	24	13	6	41	29	110	10-4F42EDMXS	10-4F42EDMXSS	350	350
14, 15, 16	5/8	3/8-19	7/8-14	24	12	9	43	31	65	10-6F42EDMXS	10-6F42EDMXSS	350	350
14, 15, 16	5/8	3/4-14	7/8-14	32	12	12	48	32	160	10-12F42EDMXS	10-12F42EDMXSS	350	350
14, 15, 16	5/8	1-11	7/8-14	41	13	13	51	33	205	10-16F42EDMXS	10-16F42EDMXSS	280	280
18, 20	3/4	3/4-14	1 1/16-12	32	16	16	51	35	165	12F42EDMXS	12F42EDMXSS	350	350
18, 20	3/4	3/8-19	1 1/16-12	27	16	9	50	38	105	12-6F42EDMXS	12-6F42EDMXSS	350	350
18, 20	3/4	1/2-14	1 1/16-12	27	16	14	49	35	118	12-8F42EDMXS	12-8F42EDMXSS	350	350
18, 20	3/4	1-11	1 1/16-12	41	16	16	54	35	292	12-16F42EDMXS	12-16F42EDMXSS	280	280
18, 20	3/4	1 1/4-11	1 1/16-12	50	16	30	62	42	220	12-20F42EDMXS	12-20F42EDMXSS	280	210
22	7/8	3/4-14	1 3/16-12	32	18	18	51	35	173	14F42EDMXS	14F42EDMXSS	280	280
25	1	1-11	1 5/16-12	41	22	22	55	37	262	16F42EDMXS	16F42EDMXSS	280	280
25	1	1/2-14	1 5/16-12	41	22	14	51	37	145	16-8F42EDMXS	16-8F42EDMXSS	280	280
25	1	3/4-14	1 5/16-12	36	22	18	53	37	217	16-12F42EDMXS	16-12F42EDMXSS	280	280
25	1	1 1/4-11	1 5/16-12	50	22	22	59	39	386	16-20F42EDMXS	16-20F42EDMXSS	280	280
28, 30, 32	1 1/4	1 1/4-11	1 5/8-12	50	28	28	60	40	375	20F42EDMXS	20F42EDMXSS	280	210
28, 30, 32	1 1/4	3/4-14	1 5/8-12	50	28	18	56	40	220	20-12F42EDMXS	20-12F42EDMXSS	280	210
28, 30, 32	1 1/4	1-11	1 5/8-12	46	28	23	62	44	255	20-16F42EDMXS	20-16F42EDMXSS	280	210
28, 30, 32	1 1/4	1 1/2-11	1 5/8-12	55	28	28	64	42	420	20-24F42EDMXS	20-24F42EDMXSS	210	140
35, 38	1 1/2	1 1/2-11	1 7/8-12	55	33	33	67	45	480	24F42EDMXS	24F42EDMXSS	210	140
35, 38	1 1/2	1-11	1 7/8-12	50	33	23	63	45	390	24-16F42EDMXS	24-16F42EDMXSS	210	210
35, 38	1 1/2	1 1/4-11	1 7/8-12	50	33	30	62	42	420	24-20F42EDMXS	24-20F42EDMXSS	210	210
42		1 1/2-11	2 1/4-12	60	39	36	71	49	746	28-24F42EDMXS	28-24F42EDMXSS	140	105

Triple-Lok® Verschraubungen werden standardmäßig mit NBR Dichtung geliefert. Für alternative Dichtungswerkstoffe siehe Seite K93
Die angegebenen Artikel entsprechen unserem Standard-Lieferprogramm. Zöllige und metrische Versionen können sich in der Schlüsselweite unterscheiden.

$$\frac{\text{PN (bar)}}{10} = \text{PN (MPa)}$$

Die angegebenen Nenndrücke PN beziehen sich auf die Stahl- und Edelstahlversion der Verschraubung.

F4OMX Gerader Einschraubstutzen

Triple-Lok® 37° Bördelanschluss / Zöll. Einschraubzapfen – O-Ring + Kammerring (ISO 1179)

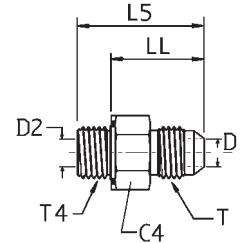

Rohr A.D.		Gewinde BSPP T4	Gewinde UN/UNF-2A T	C4 mm	D mm	D2 mm	L5 mm	LL mm	Gewicht (Stahl) g/1 St.	Triple-Lok® Stahl	Triple-Lok® Edelstahl	PN (bar)	
mm	Zoll											S	SS
6	1/4	1/8-28	7/16-20	16	4	4	28	22	20	4F4OMXS	4F4OMXS	350	350
6	1/4	1/4-19	7/16-20	19	4	4	32	23	34	4-4F4OMXS	4-4F4OMXS	350	350
6	1/4	3/8-19	7/16-20	22	4	4	33	24	47	4-6F4OMXS	4-6F4OMXS	350	350
6	1/4	1/2-14	7/16-20	30	4	4	39	26	99	4-8F4OMXS	4-8F4OMXS	350	350
8	5/16	1/8-28	1/2-20	16	6	4	28	22	25	5F4OMXS	5F4OMXS	350	350
8	5/16	1/4-19	1/2-20	19	6	6	32	23	30	5-4F4OMXS	5-4F4OMXS	350	350
8	5/16	3/8-19	1/2-20	22	6	6	33	24	47	5-6F4OMXS	5-6F4OMXS	350	350
10	3/8	1/4-19	9/16-18	19	8	6	33	23	28	6F4OMXS	6F4OMXS	350	350
10	3/8	1/8-28	9/16-18	16	8	4	29	23	27	6-2F4OMXS	6-2F4OMXS	350	350
10	3/8	3/8-19	9/16-18	22	8	8	33	24	40	6-6F4OMXS	6-6F4OMXS	350	350
10	3/8	1/2-14	9/16-18	30	8	8	38	25	25	6-8F4OMXS	6-8F4OMXS	350	350
10	3/8	3/4-14	9/16-18	36	8	8	40	25	100	6-12F4OMXS	6-12F4OMXS	280	280
12	1/2	3/8-19	3/4-16	22	10	10	36	27	50	8F4OMXS	8F4OMXS	350	350
12	1/2	1/4-19	3/4-16	19	10	6	35	26	40	8-4F4OMXS	8-4F4OMXS	350	350
12	1/2	1/2-14	3/4-16	30	10	10	41	29	100	8-8F4OMXS	8-8F4OMXS	350	350
12	1/2	3/4-14	3/4-16	36	10	10	42	30	100	8-12F4OMXS	8-12F4OMXS	280	250
12	1/2	1-11	3/4-16	46	10	10	47	29	150	8-16F4OMXS	8-16F4OMXS	280	250
14, 15, 16	5/8	1/2-14	7/8-14	30	12	12	43	31	103	10F4OMXS	10F4OMXS	350	350
14, 15, 16	5/8	1/4-19	7/8-14	24	12	6	39	28	110	10-4F4OMXS	10-4F4OMXS	350	350
14, 15, 16	5/8	3/8-19	7/8-14	24	12	9	39	30	65	10-6F4OMXS	10-6F4OMXS	350	350
14, 15, 16	5/8	3/4-14	7/8-14	36	12	12	45	32	160	10-12F4OMXS	10-12F4OMXS	280	250
18, 20	3/4	3/4-14	1 1/16-12	36	16	16	48	35	165	12F4OMXS	12F4OMXS	280	250
18, 20	3/4	3/8-19	1 1/16-12	27	16	9	44	34	97	12-6F4OMXS	12-6F4OMXS	350	250
18, 20	3/4	1/2-14	1 1/16-12	30	16	12	47	34	118	12-8F4OMXS	12-8F4OMXS	350	350
18, 20	3/4	1-11	1 1/16-12	46	16	16	53	37	292	12-16F4OMXS	12-16F4OMXS	280	250
18, 20	3/4	1 1/4-11	1 1/16-12	50	16	16	53	34	220	12-20F4OMXS	12-20F4OMXS	250	175
25	1	1-11	1 5/16-12	46	22	22	54	38	262	16F4OMXS	16F4OMXS	280	250
25	1	1/2-14	1 5/16-12	36	22	12	49	34	145	16-8F4OMXS	16-8F4OMXS	280	250
25	1	3/4-14	1 5/16-12	36	22	16	49	36	173	16-12F4OMXS	16-12F4OMXS	280	250
25	1	1 1/4-11	1 5/16-12	50	22	22	55	39	386	16-20F4OMXS	16-20F4OMXS	250	175
28, 30, 32	1 1/4	1 1/4-11	1 5/8-12	50	28	28	56	40	325	20F4OMXS	20F4OMXS	250	175
28, 30, 32	1 1/4	3/4-14	1 5/8-12	46	28	16	51	36	220	20-12F4OMXS	20-12F4OMXS	280	175
28, 30, 32	1 1/4	1-11	1 5/8-12	46	28	22	55	39	330	20-16F4OMXS	20-16F4OMXS	280	210
28, 30, 32	1 1/4	1 1/2-11	1 5/8-12	55	28	28	57	41	480	20-24F4OMXS	20-24F4OMXS	210	140
35, 38	1 1/2	1 1/2-11	1 7/8-12	55	33	33	61	45	480	24F4OMXS	24F4OMXS	210	140
35, 38	1 1/2	1 1/4-11	1 7/8-12	50	33	28	60	44	420	24-20F4OMXS	24-20F4OMXS	210	140
42	1 1/2	1 1/2-11	2 1/4	60	39	33	68	52	740	28-24F4OMXS	28-24F4OMXS	140	105

Triple-Lok® Verschraubungen werden standardmäßig mit NBR Dichtung geliefert. Für alternative Dichtungswerkstoffe siehe Seite K93

Die angegebenen Artikel entsprechen unserer Standard-Lieferprogramm.

Zöllige und metrische Versionen können sich in der Schlüsselweite unterscheiden.

$$\frac{\text{PN (bar)}}{10} = \text{PN (MPa)}$$

Die angegebenen Nenndrücke PN beziehen sich auf die Stahl- und Edelstahlversion der Verschraubung.

F82EDMX Gerader Einschraubstutzen

Triple-Lok® 37° Bördelanschluss / Metr. Einschraubzapfen – ED (ISO 9974)

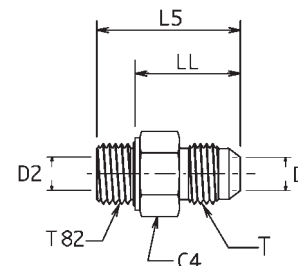

Rohr A.D. mm	Zoll	Gewinde Metrisch T82	Gewinde UN/UNF-2A T	C4 mm	D mm	D2 mm	L5 mm	LL mm	Gewicht (Stahl) g/1 St.	Triple-Lok® Stahl	Triple-Lok® Edelstahl	PN (bar)	
												S	SS
6	1/4	M10 × 1,0	7/16-20	14	4	4	30	22	19	4M10F82EDMXS	4M10F82EDMXSS	500	350
6	1/4	M12 × 1,5	7/16-20	17	4	4	34	22	30	4M12F82EDMXS	4M12F82EDMXSS	420	350
8	5/16	M10 × 1,0	1/2-20	14	6	4	30	22	17	5M10F82EDMXS	5M10F82EDMXSS	420	350
8	5/16	M12 × 1,5	1/2-20	17	6	5	34	22	28	5M12F82EDMXS	5M12F82EDMXSS	420	350
8	5/16	M14 × 1,5	1/2-20	19	6	7	36	24	35	5M14F82EDMXS	5M14F82EDMXSS	420	350
10	3/8	M12 × 1,5	9/16-18	17	8	5	35	23	33	6M12F82EDMXS	6M12F82EDMXSS	420	350
10	3/8	M14 × 1,5	9/16-18	19	8	7	35	23	38	6M14F82EDMXS	6M14F82EDMXSS	420	350
10	3/8	M16 × 1,5	9/16-18	22	8	8	36	24	53	6M16F82EDMXS	6M16F82EDMXSS	420	350
10	3/8	M18 × 1,5	9/16-18	24	8	8	36	24	60	6M18F82EDMXS	6M18F82EDMXSS	350	350
10	3/8	M22 × 1,5	9/16-18	27	8	8	39	25	68	6M22F82EDMXS	6M22F82EDMXSS	350	350
12	1/2	M14 × 1,5	3/4-16	19	10	7	39	27	41	8M14F82EDMXS	8M14F82EDMXSS	420	350
12	1/2	M16 × 1,5	3/4-16	22	10	9	39	27	57	8M16F82EDMXS	8M16F82EDMXSS	420	350
12	1/2	M18 × 1,5	3/4-16	24	10	10	39	27	71	8M18F82EDMXS	8M18F82EDMXSS	350	350
12	1/2	M22 × 1,5	3/4-16	27	10	10	42	28	70	8M22F82EDMXS	8M22F82EDMXSS	350	350
14, 15, 16	5/8	M18 × 1,5	7/8-14	24	12	11	43	31	104	10M18F82EDMXS	10M18F82EDMXSS	350	350
14, 15, 16	5/8	M20 × 1,5	7/8-14	27	11	11	46	32	90	10M20F82EDMXS	10M20F82EDMXSS	350	350
14, 15, 16	5/8	M22 × 1,5	7/8-14	27	12	12	45	31	161	10M22F82EDMXS	10M22F82EDMXSS	350	350
18, 20	3/4	M18 × 1,5	1 1/16-12	27	16	11	46	34	85	12M18F82EDMXS	12M18F82EDMXSS	350	350
18, 20	3/4	M22 × 1,5	1 1/16-12	27	16	14	49	35	273	12M22F82EDMXS	12M22F82EDMXSS	350	350
18, 20	3/4	M26 × 1,5	1 1/16-12	32	16	16	51	35	135	12M26F82EDMXS	12M26F82EDMXSS	350	350
18, 20	3/4	M27 × 2,0	1 1/16-12	32	16	16	51	35	431	12M27F82EDMXS	12M27F82EDMXSS	350	350
25	1	M26 × 1,5	1 5/16-12	41	22	18	55	39	350	16M26F82EDMXS	16M26F82EDMXSS	280	280
25	1	M27 × 2,0	1 5/16-12	36	16	16	53	37	360	16M27F82EDMXS	16M27F82EDMXSS	280	280
25	1	M33 × 2,0	1 5/16-12	41	22	22	55	37	431	16M33F82EDMXS	16M33F82EDMXSS	280	280
28, 30, 32	1 1/4	M42 × 2,0	1 5/8-12	50	28	28	60	40	431	20M42F82EDMXS	20M42F82EDMXSS	280	210
35, 38	1 1/2	M48 × 2,0	1 7/8-12	55	33	33	67	45	580	24M48F82EDMXS	24M48F82EDMXSS	210	140

Triple-Lok® Verschraubungen werden standardmäßig mit NBR Dichtung geliefert. Für alternative Dichtungswerkstoffe siehe Seite K93
Die angegebenen Artikel entsprechen unserem Standard-Lieferprogramm.
Zöllige und metrische Versionen können sich in der Schlüsselweite unterscheiden.

$$\frac{\text{PN (bar)}}{10} = \text{PN (MPa)}$$

Die angegebenen Nenndrücke PN beziehen sich auf die Stahl- und Edelstahlversion der Verschraubung.

F8OMX Gerader Einschraubstutzen

Triple-Lok® 37° Bördelanschluss / Metr. Einschraubzapfen – O-Ring + Kammerring

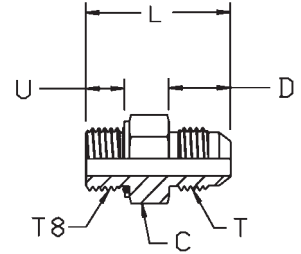

Rohr A.D.	Zoll	Gewinde Metrisch T8	Gewinde UN/UNF-2A T	L mm	D mm	C mm	U mm	Gewicht (Stahl) g/1 St.	Triple-Lok® Stahl	Triple-Lok® Edelstahl	PN (bar)	
											S	SS
6	1/4	M10 × 1,0	7/16-20	30	14	14	9	25	4M10F8OMXS	4M10F8OMXSS	350	350
6	1/4	M12 × 1,5	7/16-20	33	14	17	11	35	4M12F8OMXS	4M12F8OMXSS	420	350
8	5/16	M10 × 1,0	1/2-20	30	14	14	9	25	5M10F8OMXS	5M10F8OMXSS	350	350
8	5/16	M12 × 1,5	1/2-20	33	14	19	11	35	5M12F8OMXS	5M12F8OMXSS	420	350
8	5/16	M14 × 1,5	1/2-20	34	14	19	11	35	5M14F8OMXS	5M14F8OMXSS	350	350
10	3/8	M12 × 1,5	9/16-18	34	14	17	11	35	6M12F8OMXS	6M12F8OMXSS	420	350
10	3/8	M14 × 1,5	9/16-18	34	14	19	11	35	6M14F8OMXS	6M14F8OMXSS	350	350
10	3/8	M16 × 1,5	9/16-18	36	14	22	12	51	6M16F8OMXS	6M16F8OMXSS	350	350
10	3/8	M18 × 1,5	9/16-18	37	14	24	13	60	6M18F8OMXS	6M18F8OMXSS	250	350
12	1/2	M14 × 1,5	3/4-16	36	17	19	11	38	8M14F8OMXS	8M14F8OMXSS	350	350
12	1/2	M16 × 1,5	3/4-16	38	17	22	12	55	8M16F8OMXS	8M16F8OMXSS	350	350
12	1/2	M18 × 1,5	3/4-16	39	17	24	13	66	8M18F8OMXS	8M18F8OMXSS	250	250
12	1/2	M22 × 1,5	3/4-16	41	17	27	13	70	8M22F8OMXS	8M22F8OMXSS	250	250
14, 15,16	5/8	M18 × 1,5	7/8-14	43	19	24	13	71	10M18F8OMXS	10M18F8OMXSS	250	250
14, 15,16	5/8	M22 × 1,5	7/8-14	45	19	27	14	90	10M20F8OMXS	10M20F8OMXSS	250	250
14, 15,16	5/8	M22 × 1,5	7/8-14	44	19	27	13	98	10M22F8OMXS	10M22F8OMXSS	250	250
18, 20	3/4	M18 × 1,5	1 1/16-12	51	22	27	13	85	12M18F8OMXS	12M18F8OMXSS	250	250
18, 20	3/4	M22 × 1,5	1 1/16-12	48	22	27	13	104	12M22F8OMXS	12M22F8OMXSS	250	250
18, 20	3/4	M24 × 1,5	1 1/16-12	45	22	30	12	120	12M24F8OMXS	12M24F8OMXSS	210	210
18, 20	3/4	M27 × 2,0	1 1/16-12	51	22	32	16	154	12M27F8OMXS	12M27F8OMXSS	210	210
25	1	M22 × 1,5	1 5/16-12	48	23	36	13	180	16M22F8OMXS	16M22F8OMXSS	250	250
25	1	M26 × 1,5	1 5/16-12	52	23	36	17	202	16M26F8OMXS	16M26F8OMXSS	210	210
25	1	M27 × 2,0	1 5/16-12	51	23	36	16	202	16M27F8OMXS	16M27F8OMXSS	210	210
25	1	M33 × 2,0	1 5/16-12	53	23	41	16	267	16M33F8OMXS	16M33F8OMXSS	210	210
28, 30, 32	1 1/4	M42 × 2,0	1 5/8-12	55	24	50	16	427	20M42F8OMXS	20M42F8OMXSS	210	210
35, 38	1 1/2	M48 × 2,0	1 7/8-12	59	28	55	18	545	24M48F8OMXS	24M48F8OMXSS	140	140

Triple-Lok® Verschraubungen werden standardmäßig mit NBR Dichtung geliefert. Für alternative Dichtungswerkstoffe siehe Seite K93

Die angegebenen Artikel entsprechen unserem Standard-Lieferprogramm.

Zöllige und metrische Versionen können sich in der Schlüsselweite unterscheiden.

$$\frac{\text{PN (bar)}}{10} = \text{PN (MPa)}$$

Die angegebenen Nenndrücke PN beziehen sich auf die Stahl- und Edelstahlversion der Verschraubung.

FMTX Gerader Einschraubstutzen

Triple-Lok® 37° Bördelanschluss / NPTF* Einschraubzapfen (SAE J476)

SAE 070102 MS51500

*Edelstahl = NPT Gewinde

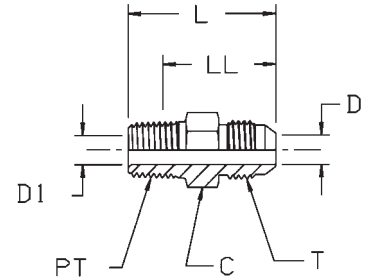

Rohr A.D.	mm	Zoll	Gewinde NPT/NPTF PT	Gewinde UN/UNF-2A T	C mm	D mm	D1 mm	L mm	LL mm	Gewicht (Stahl) g/1 St.	Triple-Lok®			PN (bar)	
											Stahl	Edelstahl	Messing	S	SS
5	6	1/8	1/8-27	5/16-24	11	2	5	28	22	10	2 FTX-S			420	—
		3/16	1/8-27	3/8-24	11	3	5	29	23	12	3 FTX-S			420	—
		1/4	1/8-27	7/16-20	13	4	4	31	23	14	4FMTXS	4FMTXSS	4FMTXB	420	350
		1/4	1/4-18	7/16-20	14	4	4	36	24	26	4-4FMTXS	4-4FMTXSS	4-4FMTXB	420	350
		1/4	3/8-18	7/16-20	19	4	10	37	28	26	4-6 FTX-S	4-6FMTXSS	4-6FMTXB	420	350
		1/4	1/2-14	7/16-20	22	4	14	43	31	26	4-8 FTX-S	4-8FMTXSS	4-8FMTXB	420	350
8	10	5/16	1/8-27	1/2-20	14	6	5	31	23	17	5FMTXS	5FMTXSS	5FMTXB	420	350
		5/16	1/4-18	1/2-20	14	6	6	36	24	25	5-4FMTXS	5-4FMTXSS	5-4FMTXB	420	350
		5/16	3/8-18	1/2-20	19	6	6	36	26	30	5-6FMTXS	5-6FMTXSS	5-6FMTXB	420	350
		3/8	1/4-16	9/16-18	16	8	8	36	25	25	6FMTXS	6FMTXSS	6FMTXB	420	350
		3/8	1/8-27	9/16-18	16	8	5	32	26	21	6-2 FTX-S	6-2FMTXSS	6-2FMTXB	420	350
		10	12	3/8	3/8-18	9/16-18	19	8	8	36	25	39	6-6FMTXS	6-6FMTXSS	6-6FMTXB
3/8	1/2-14			9/16-18	22	8	8	43	28	47	6-8FMTXS	6-8FMTXSS	6-8FMTXB	420	350
1/2	3/8-18			3/4-16	19	10	10	39	27	45	8FMTXS	8FMTXSS	8FMTXB	420	350
1/2	1/4-16			3/4-16	19	10	7	39	27	42	8-4FMTXS	8-4FMTXSS	8-4FMTXB	420	350
1/2	1/2-14			3/4-16	22	10	10	46	30	74	8-8FMTXS	8-8FMTXSS	8-8FMTXB	420	350
12	14, 15, 16			1/2	3/4-14	3/4-16	27	10	10	47	31	121	8-12FMTXS	8-12FMTXSS	8-12FMTXB
		5/8	1/2-14	7/8-14	24	12	12	48	33	77	10FMTXS	10FMTXSS	10FMTXB	350	350
		5/8	3/8-18	7/8-14	24	12	10	43	31	63	10-6FMTXS	10-6FMTXSS	10-6FMTXB	350	350
		5/8	3/4-14	7/8-14	27	12	12	50	34	122	10-12FMTXS	10-12FMTXSS	10-12FMTXB	350	350
		3/4	3/4-14	1 1/16-12	27	16	16	52	37	123	12FMTXS	12FMTXSS	12FMTXB	350	350
		18, 20	22, 25	3/4	3/8-18	1 1/16-12	29	16	10	48	39	90	12-6 FTX-S	12-6FMTXSS	12-6FMTXB
3/4	1/2-14			1 1/16-12	27	16	14	52	37	103	12-8FMTXS	12-8FMTXSS	12-8FMTXB	350	350
3/4	1-11 1/2			1 1/16-12	36	16	16	57	38	176	12-16FMTXS	12-16FMTXSS	12-16FMTXB	310	280
7/8	3/4-14			1 3/16-12	32	18	18	53	41	137	14 FTX-S	14FMTXSS	14FMTXB	280	245
1	1-11 1/2			1 5/16-12	36	22	22	58	39	189	16FMTXS	16FMTXSS	16FMTXB	280	280
28, 30, 32	35, 38			1	1/2-14	1 5/16-12	35	22	14	54	42	110	16-8 FTX-S	16-8FMTXSS	16-8FMTXB
		1	3/4-14	1 5/16-12	36	22	18	54	38	149	16-12FMTXS	16-12FMTXSS	16-12FMTXB	280	280
		1 1/4	1 1/4-11 1/2	1 5/8-12	46	28	28	62	42	315	20FMTXS	20FMTXSS	20FMTXB	210	210
		1 1/4	1-11 1/2	1 5/8-12	46	28	24	61	42	248	20-16FMTXS	20-16FMTXSS	20-16FMTXB	280	210
		1 1/2	1 1/2-11 1/2	1 7/8-12	50	33	33	68	48	430	24FMTXS	24FMTXSS	24FMTXB	210	140
		35, 38	35, 38	1 1/2	1-11 1/2	1 7/8-12	50	33	24	67	52	310	24-16 FTX-S	24-16FMTXSS	24-16FMTXB
1 1/2	1 1/4-11 1/2			1 7/8-12	50	33	32	67	47	359	24-20FMTXS	24-20FMTXSS	24-20FMTXB	210	140
1 1/2	2-11 1/2			1 7/8-12	68	33	33	73	57	720	24-32 FTX-S	24-32FMTXSS	24-32FMTXB	140	140
2	2-11/12			2 1/2-12	67	45	49	79	64	858	32 FTX-S	32FMTXSS	32FMTXB	140	105
2	1 1/2-11 1/2			2 1/2-12	68	45	38	78	63	720	32-24 FTX-S	32-24FMTXSS	32-24FMTXB	140	105

Die angegebenen Artikel entsprechen unsererem Standard-Lieferprogramm.
Zöllige und metrische Versionen können sich in der Schlüsselweite unterscheiden.

$$\frac{PN \text{ (bar)}}{10} = PN \text{ (MPa)}$$

Die angegebenen Nenndrücke PN beziehen sich auf die Stahl- und Edelstahlversion der Verschraubung.
Für Messingverschraubungen sind diese Drücke um 35% zu reduzieren.

F3MX Gerader Einschraubstutzen

Triple-Lok® 37° Bördelanschluss / Zöll. (BSPT) Einschraubzapfen – kegelig (ISO 7)

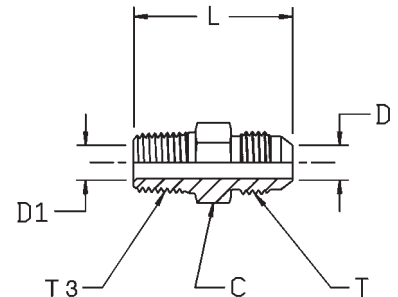

Rohr A.D. mm	Zoll	Gewinde BSPT T3	Gewinde UN/UNF-2A T	C mm	D mm	D1 mm	L mm	Gewicht (Stahl) g/1 St.	Triple-Lok® Stahl	Triple-Lok® Edelstahl	PN (bar)	
											S	SS
6	1/4	1/8-28	7/16-20	13	4	4	31	13	4F3MXS	4F3MXSS	315	315
6	1/4	1/4-19	7/16-20	14	4	4	36	25	4-4F3MXS	4-4F3MXSS	315	315
8	5/16	1/8-28	1/2-20	14	6	5	31	17	5F3MXS	5F3MXSS	315	315
8	5/16	1/4-19	1/2-20	14	6	6	36	24	5-4F3MXS	5-4F3MXSS	315	315
10	3/8	1/4-19	9/16-18	16	8	8	36	25	6F3MXS	6F3MXSS	315	315
10	3/8	3/8-19	9/16-18	19	8	8	36	37	6-6F3MXS	6-6F3MXSS	315	315
10	3/8	1/2-14	9/16-18	22	8	8	43	45	6-8F3MXS	6-8F3MXSS	315	315
12	1/2	3/8-19	3/4-16	19	10	10	39	43	8F3MXS	8F3MXSS	315	315
12	1/2	1/4-19	3/4-16	19	10	7	39	41	8-4F3MXS	8-4F3MXSS	315	315
12	1/2	1/2-14	3/4-16	22	10	10	46	71	8-8F3MXS	8-8F3MXSS	315	315
14, 15, 16	5/8	1/2-14	7/8-14	24	12	12	48	74	10F3MXS	10F3MXSS	315	315
14, 15, 16	5/8	3/8-19	7/8-14	24	12	10	43	61	10-6F3MXS	10-6F3MXSS	315	315
14, 15, 16	5/8	3/4-14	7/8-14	27	12	12	50	117	10-12F3MXS	10-12F3MXSS	160	160
18, 20	3/4	3/4-14	1 1/16-12	27	16	16	52	119	12F3MXS	12F3MXSS	160	160
18, 20	3/4	1/2-14	1 1/16-12	27	16	14	52	100	12-8F3MXS	12-8F3MXSS	315	315
18, 20	3/4	1-11	1 1/16-12	36	16	16	57	214	12-16F3MXS	12-16F3MXSS	160	160
25	1	1-11	1 5/16-12	36	22	22	58	185	16F3MXS	16F3MXSS	160	160
25	1	3/4-14	1 5/16-12	36	22	18	54	146	16-12F3MXS	16-12F3MXSS	160	160
28, 30, 32	1 1/4	1 1/4-11	1 5/8-12	46	28	28	62	309	20F3MXS	20F3MXSS	160	160
28, 30, 32	1 1/4	1-11	1 5/8-12	46	28	24	61	243	20-16F3MXS	20-16F3MXSS	160	160
35, 38	1 1/2	1 1/2-11	1 7/8-12	50	33	33	68	421	24F3MXS	24F3MXSS	160	140
35, 38	1 1/2	1 1/4-11	1 7/8-12	50	33	32	67	352	24-20F3MXS	24-20F3MXSS	160	140

Die angegebenen Artikel entsprechen unserem Standard-Lieferprogramm.
Zöllige und metrische Versionen können sich in der Schlüsselweite unterscheiden.

$$\frac{\text{PN (bar)}}{10} = \text{PN (MPa)}$$

Die angegebenen Nenndrücke PN beziehen sich auf die Stahl- und Edelstahlversion der Verschraubung.

F687OMX Gerader Einschraubadapter

Triple-Lok® 37° Swivel, einstellbar / Metr. Einschraubzapfen – O-Ring (ISO 6149)

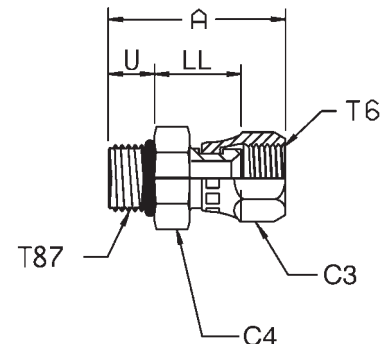

Rohr A.D.		Gewinde Metrisch T87	Gewinde UN/UNF-2B T6	A mm	LL mm	U mm	C3 mm	C4 mm	Gewicht (Stahl) g/1 St.	Triple-Lok® Stahl	Triple-Lok® Edelstahl	PN (bar)	
mm	Zoll											S	SS
6	1/4	M10 × 1,0	7/16-20	34	15	9	16	14	25	4M10F687OMXS	4M10F687OMXSS	500	350
6	1/4	M12 × 1,5	7/16-20	38	15	11	16	17	30	4M12F687OMXS	4M12F687OMXSS	420	350
8	5/16	M10 × 1,5	1/2-20	39	18	9	17	17	40	5M10F687OMXS	5M10F687OMXSS	420	350
8	5/16	M12 × 1,5	1/2-20	44	17	11	17	17	64	5M12F687OMXS	5M12F687OMXSS	420	350
10	3/8	M14 × 1,5	9/16-18	45	18	11	19	19	65	6M14F687OMXS	6M14F687OMXSS	350	350
10	3/8	M16 × 1,5	9/16-18	46	19	12	19	22	75	6M16F687OMXS	6M16F687OMXSS	350	350
12	1/2	M16 × 1,5	3/4-16	46	21	12	22	22	80	8M16F687OMXS	8M16F687OMXSS	350	350
12	1/2	M18 × 1,5	3/4-16	47	21	13	22	24	90	8M18F687OMXS	8M18F687OMXSS	350	350
14, 15, 16	5/8	M18 × 1,5	7/8-14	47	23	13	27	24	108	10M18F687OMXS	10M18F687OMXSS	350	350
14, 15, 16	5/8	M22 × 1,5	7/8-14	49	23	13	27	27	115	10M22F687OMXS	10M22F687OMXSS	350	350
18, 20	3/4	M22 × 1,5	1 1/16-12	53	25	13	32	27	183	12M22F687OMXS	12M22F687OMXSS	350	350
18, 20	3/4	M27 × 2,0	1 1/16-12	54	24	16	32	32	197	12M27F687OMXS	12M27F687OMXSS	350	350
25	1	M27 × 2,0	1 5/16-12	56	25	16	38	32	230	16M27F687OMXS	16M27F687OMXSS	250	280
25	1	M33 × 2,0	1 5/16-12	58	27	16	38	41	250	16M33F687OMXS	16M33F687OMXSS	250	280
28, 30, 32	1 1/4	M42 × 2,0	1 5/8-12	73	31	16	50	50	500	20M42F687OMXS	20M42F687OMXSS	250	210
35, 38	1 1/2	M48 × 2,0	1 7/8-12	72	33	18	60	55	688	24M48F687OMXS	24M48F687OMXSS	170	140

Triple-Lok® Verschraubungen werden standardmäßig mit NBR Dichtung geliefert. Für alternative Dichtungswerkstoffe siehe Seite K93
Die angegebenen Artikel entsprechen unserem Standard-Lieferprogramm.
Zöllige und metrische Versionen können sich in der Schlüsselweite unterscheiden.

$$\frac{\text{PN (bar)}}{10} = \text{PN (MPa)}$$

Die angegebenen Nenndrücke PN beziehen sich auf die Stahl- und Edelstahlversion der Verschraubung.

F65OMX Gerader Einschraubadapter

Triple-Lok® 37° Swivel, einstellbar / UN/UNF Einschraubzapfen – O-Ring (ISO 11926)

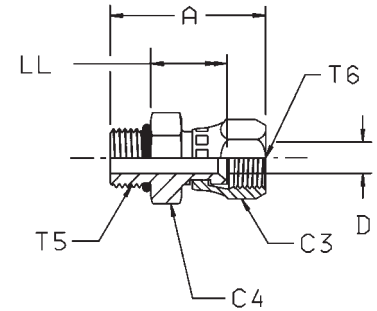

Rohr A.D.		Gewinde UNF T5	Gewinde UN/UNF-2B T6	A mm	C3 mm	C4 mm	D mm	LL mm	Gewicht (Stahl) g/1 St.	Triple-Lok® Stahl	PN (bar)
6	1/4	7/16-20	7/16-20	34	16	14	4	15	27	4F65OMXS	500
8	5/16	1/2-20	1/2-20	34	17	17	6	17	30	5F65OMXS	420
10	3/8	9/16-18	9/16-18	36	19	17	8	16	35	6F65OMXS	350
12	1/2	3/4-16	3/4-16	42	22	22	10	21	64	8F65OMXS	350
14, 15, 16	5/8	7/8-14	7/8-14	47	27	27	12	23	112	10F65OMXS	350
18, 20	3/4	1 1/16-12	1 1/16-12	52	32	32	16	24	183	12F65OMXS	350
25	1	1 5/16-12	1 5/16-12	55	38	41	22	27	234	16F65OMXS	250
28, 30, 32	1 1/4	1 5/8-12	1 5/8-12	63	50	50	28	32	500	20F65OMXS	250

Triple-Lok® Verschraubungen werden standardmäßig mit NBR Dichtung geliefert. Für alternative Dichtungswerkstoffe siehe Seite K93
Die angegebenen Artikel entsprechen unserem Standard-Lieferprogramm.
Zöllige und metrische Versionen können sich in der Schlüsselweite unterscheiden.

$$\frac{\text{PN (bar)}}{10} = \text{PN (MPa)}$$

K

F642EDMX Gerader Einschraubadapter

Triple-Lok® 37° Swivel, einstellbar / Zöll. Einschraubzapfen – ED (ISO 1179)

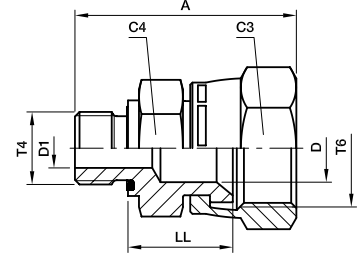

Rohr A.D.		Gewinde BSPP T4	Gewinde UN/UNF-2B T6	A mm	C3 mm	C4 mm	D mm	D1 mm	LL mm	Gewicht (Stahl) g/1 St.	Triple-Lok® Stahl	Triple-Lok® Edelstahl	PN (bar)	
mm	Zoll												S	SS
6	1/4	1/8-28	7/16-20	24	16	14	4	4	15	30	4F642EDMXS	4F642EDMXSS	500	350
6	1/4	1/4-19	7/16-20	29	16	19	4	4	16	30	4-4F642EDMXS	4-4F642EDMXSS	420	350
8	5/16	1/8-28	1/2-20	25	17	14	6	4	17	28	5F642EDMXS	5F642EDMXSS	420	350
8	5/16	1/4-19	1/2-20	29	17	19	6	6	18	37	5-4F642EDMXS	5-4F642EDMXSS	420	350
10	3/8	1/4-19	9/16-18	30	19	19	8	6	18	41	6F642EDMXS	6F642EDMXSS	350	350
10	3/8	3/8-19	9/16-18	31	19	22	8	8	19	57	6-6F642EDMXS	6-6F642EDMXSS	350	350
12	1/2	3/8-19	3/4-16	33	22	22	10	9	21	62	8F642EDMXS	8F642EDMXSS	350	350
12	1/2	1/4-19	3/4-16	33	22	19	10	6	21	60	8-4F642EDMXS	8-4F642EDMXSS	350	350
12	1/2	1/2-14	3/4-16	34	22	27	10	10	23	75	8-8F642EDMXS	8-8F642EDMXSS	350	350
14, 15,16	5/8	1/2-14	7/8-14	37	27	27	12	12	23	127	10F642EDMXS	10F642EDMXSS	350	350
14, 15,16	5/8	3/8-19	7/8-14	35	27	22	12	9	23	84	10-6F642EDMXS	10-6F642EDMXSS	350	350
18, 20	3/4	3/4-14	1 1/16-12	42	32	32	16	16	24	183	12F642EDMXS	12F642EDMXSS	350	350
18, 20	3/4	1/2-14	1 1/16-12	40	32	27	16	14	25	170	12-8F642EDMXS	12-8F642EDMXSS	350	350
25	1	1-11	1 5/16-12	45	38	41	22	22	27	296	16F642EDMXS	16F642EDMXSS	250	250
25	1	3/4-14	1 5/16-12	43	38	36	22	18	27	254	16-12F642EDMXS	16-12F642EDMXSS	250	250
28, 30, 33	1 1/4	1 1/4-11	1 5/8-12	52	50	50	28	28	32	500	20F642EDMXS	20F642EDMXSS	250	210
28, 30, 32	1 1/4	1-11	1 5/8-12	54	50	41	28	23	36	440	20-16F642EDMXS	20-16F642EDMXSS	250	210
35, 38	1 1/2	1 1/2-11	1 7/8-12	58	60	55	33	33	36	739	24F642EDMXS	24F642EDMXSS	170	140
35, 38	1 1/2	1 1/4-11	1 7/8-12	60	60	50	33	30	33	627	24-20F642EDMXS	24-20F642EDMXSS	170	140

Triple-Lok® Verschraubungen werden standardmäßig mit NBR Dichtung geliefert. Für alternative Dichtungswerkstoffe siehe Seite K93

Die angegebenen Artikel entsprechen unserem Standard-Lieferprogramm.

Zöllige und metrische Versionen können sich in der Schlüsselweite unterscheiden.

$$\frac{\text{PN (bar)}}{10} = \text{PN (MPa)}$$

Die angegebenen Nenndrücke PN beziehen sich auf die Stahl- und Edelstahlversion der Verschraubung.

F64OMX Gerader Einschraubadapter

Triple-Lok® 37° Swivel, einstellbar /
Zöll. Einschraubzapfen – O-Ring + Kammerring (ISO 1179)

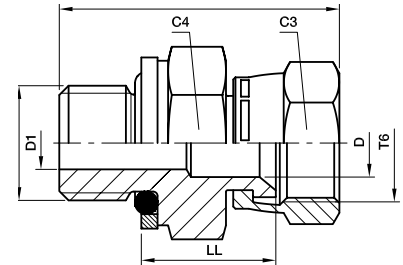

Rohr A.D.		Gewinde BSPP T4	Gewinde UN/UNF-2B T6	A mm	C3 mm	C4 mm	D mm	D1 mm	LL mm	Gewicht (Stahl) g/1 St.	Triple-Lok® Stahl	Triple-Lok® Edelstahl	PN (bar)	
mm	Zoll												S	SS
6	1/4	1/8-28	7/16-20	32	16	16	4	4	17	30	4F64OMXS	4F64OMXS	350	350
6	1/4	1/4-19	7/16-20	35	16	19	4	4	16	30	4-4F64OMXS	4-4F64OMXS	350	350
8	5/16	1/8-28	1/2-20	32	17	16	6	4	17	28	5F64OMXS	5F64OMXS	350	350
8	5/16	1/4-19	1/2-20	36	17	19	6	6	18	37	5-4F64OMXS	5-4F64OMXS	350	350
10	3/8	1/4-19	9/16-18	37	19	19	8	6	18	41	6F64OMXS	6F64OMXS	350	350
10	3/8	3/8-19	9/16-18	38	19	22	8	8	19	57	6-6F64OMXS	6-6F64OMXS	350	350
12	1/2	3/8-19	3/4-16	41	22	22	10	10	21	62	8F64OMXS	8F64OMXS	350	350
12	1/2	1/4-19	3/4-16	39	22	19	10	6	20	57	8-4F64OMXS	8-4F64OMXS	350	350
12	1/2	1/2-14	3/4-16	42	22	30	10	10	21	75	8-8F64OMXS	8-8F64OMXS	350	350
14, 15, 16	5/8	1/2-14	7/8-14	49	27	30	12	12	24	127	10F64OMXS	10F64OMXS	350	350
14, 15, 16	5/8	3/8-19	7/8-14	43	27	22	12	9	22	84	10-6F64OMXS	10-6F64OMXS	350	350
18, 20	3/4	3/4-14	1 1/16-12	51	32	36	16	16	26	183	12F64OMXS	12F64OMXS	280	280
18, 20	3/4	1/2-14	1 1/16-12	50	32	30	16	12	24	169	12-8F64OMXS	12-8F64OMXS	350	350
25	1	1-11	1 5/16-12	59	38	46	22	22	28	296	16F64OMXS	16F64OMXS	250	250
25	1	3/4-14	1 5/16-12	54	38	36	22	16	27	253	16-12F64OMXS	16-12F64OMXS	250	250
28, 30, 32	1 1/4	1 1/4-11	1 5/8-12	64	50	50	28	28	32	500	20F64OMXS	20F64OMXS	250	175
28, 30, 32	1 1/4	1-11	1 5/8-12	62	50	46	28	22	31	420	20-16F64OMXS	20-16F64OMXS	250	175
35, 38	1 1/2	1 1/2-11	1 7/8-12	70	60	55	33	33	36	739	24F64OMXS	24F64OMXS	170	140
35, 38	1 1/2	1 1/4-11	1 7/8-12	70	60	50	33	28	35	627	24-20F64OMXS	24-20F64OMXS	170	140

Triple-Lok® Verschraubungen werden standardmäßig mit NBR Dichtung geliefert. Für alternative Dichtungswerkstoffe siehe Seite K93

Die angegebenen Artikel entsprechen unsererem Standard-Lieferprogramm.

Zöllige und metrische Versionen können sich in der Schlüsselweite unterscheiden.

$$\frac{\text{PN (bar)}}{10} = \text{PN (MPa)}$$

Die angegebenen Nenndrücke PN beziehen sich auf die Stahl- und Edelstahlversion der Verschraubung.

K

F682EDMX Gerader Einschraubadapter

Triple-Lok® 37° Swivel, einstellbar / Metr. Einschraubzapfen – ED (ISO 9974)

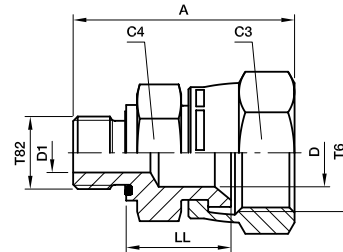

Rohr A.D.		Gewinde Metrisch T82	Gewinde UN/UNF-2B T6	A	C4	C3	D	D1	LL	Gewicht (Stahl) g/1 St.	Triple-Lok® Stahl	Triple-Lok® Edelstahl	PN (bar)	
mm	Zoll			mm	mm	mm	mm	mm	mm				S	SS
6	1/4	M10 × 1,0	7/16-20	24	14	16	4	4	15	28	4M10F682EDMXS	4M10F682EDMXSS	500	350
8	5/16	M12 × 1,5	1/2-20	29	17	17	6	5	17	32	5M12F682EDMXS	5M12F682EDMXSS	420	350
10	3/8	M14 × 1,5	9/16-18	30	19	19	8	7	18	42	6M14F682EDMXS	6M14F682EDMXSS	350	350
12	1/2	M16 × 1,5	3/4-16	34	22	22	10	9	21	62	8M16F682EDMXS	8M16F682EDMXSS	350	350
12	1/2	M18 × 1,5	3/4-16	34	24	22	10	10	21	70	8M18F682EDMXS	8M18F682EDMXSS	350	350
14, 15, 16	5/8	M18 × 1,5	7/8-14	36	24	27	12	11	23	125	10M18F682EDMXS	10M18F682EDMXSS	350	350
14, 15, 16	5/8	M22 × 1,5	7/8-14	38	27	27	12	12	23	155	10M22F682EDMXS	10M22F682EDMXSS	350	350
18, 20	3/4	M22 × 1,5	1 1/16-12	40	27	32	16	14	25	160	12M22F682EDMXS	12M22F682EDMXSS	350	350
18, 20	3/4	M27 × 2,0	1 1/16-12	42	32	32	16	16	24	172	12M27F682EDMXS	12M27F682EDMXSS	350	350
25	1	M33 × 2,0	1 5/16-12	45	41	38	22	22	27	259	16M33F682EDMXS	16M33F682EDMXSS	250	250
28, 30, 32	1 1/4	M42 × 2,0	1 5/8-12	52	50	50	28	28	32	484	20M42F682EDMXS	20M42F682EDMXSS	250	210

Triple-Lok® Verschraubungen werden standardmäßig mit NBR Dichtung geliefert. Für alternative Dichtungswerkstoffe siehe Seite K93
Die angegebenen Artikel entsprechen unsererem Standard-Lieferprogramm.
Zöllige und metrische Versionen können sich in der Schlüsselweite unterscheiden.

$$\frac{\text{PN (bar)}}{10} = \text{PN (MPa)}$$

Die angegebenen Nenndrücke PN beziehen sich auf die Stahl- und Edelstahlversion der Verschraubung.

F68OMX Gerader Einschraubadapter

Triple-Lok® 37° Swivel, einstellbar / Metr. Einschraubzapfen – O-Ring + Kammerring

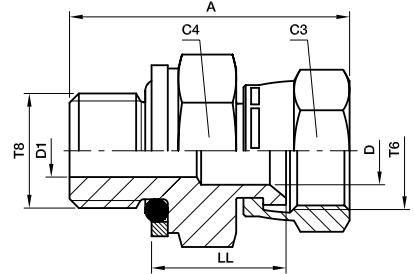

Rohr A.D.		Gewinde Metrisch T8	Gewinde UN/UNF-2B T6	A mm	C3 mm	C4 mm	D mm	D1 mm	LL mm	Gewicht (Stahl) g/1 St.	Triple-Lok® Stahl	PN (bar)
mm	Zoll											
6	1/4	M10 × 1,0	7/16-20	34	16	14	4	4	16	28	4M10F68OMXS	350
8	5/16	M12 × 1,5	1/2-20	38	17	17	6	6	18	32	5M12F68OMXS	420
10	3/8	M14 × 1,5	9/16-18	39	19	19	8	8	20	42	6M14F68OMXS	350
12	1/2	M16 × 1,5	3/4-16	42	22	22	10	8	22	62	8M16F68OMXS	350
12	1/2	M18 × 1,5	3/4-16	44	22	24	10	10	23	62	8M18F68OMXS	250
14, 15,16	5/8	M18 × 1,5	7/8-14	47	27	24	12	11	25	127	10M18F68OMXS	250
14, 15,16	5/8	M22 × 1,5	7/8-14	48	27	27	12	12	24	155	10M22F68OMXS	250
18, 20	3/4	M27 × 2,0	1 1/16-12	52	32	32	16	16	26	172	12M27F68OMXS	210
25	1	M33 × 2,0	1 5/16-12	57	38	41	22	22	29	259	16M33F68OMXS	210
28, 30, 32	1 1/4	M42 × 2,0	1 5/8-12	62	50	50	28	28	33	484	20M42F68OMXS	210

Triple-Lok® Verschraubungen werden standardmäßig mit NBR Dichtung geliefert. Für alternative Dichtungswerkstoffe siehe Seite K93
Die angegebenen Artikel entsprechen unserem Standard-Lieferprogramm.
Zöllige und metrische Versionen können sich in der Schlüsselweite unterscheiden.

$$\frac{\text{PN (bar)}}{10} = \text{PN (MPa)}$$

K

F6MX Gerader Einschraubadapter

Triple-Lok® 37° Swivel, einstellbar / NPT* Einschraubzapfen (SAE J476)

*Edelstahl = NPT Gewinde

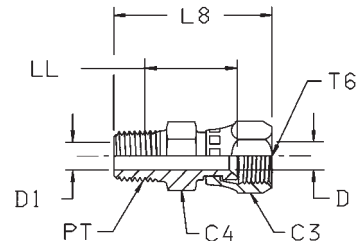

Rohr A.D. mm	Zoll	Gewinde NPT/NPTF PT	Gewinde UN/UNF-2B T6	C3 mm	C4 mm	D mm	D1 mm	L8 mm	LL mm	Gewicht (Stahl) g/1 St.	Triple-Lok® Stahl	Triple-Lok® Edelstahl	PN (bar)	
													S	SS
6	1/4	1/8-27	7/16-20	14	14	4	4	29	16	18	4 F6X-S	4F6MXSS	420	350
6	1/4	1/4-18	7/16-20	14	14	4	4	39	22	19	4-4F6MXS	4-4F6MXSS	420	350
8	5/16	1/8-27	1/2-20	17	14	6	5	35	16	26	5F6MXS	5F6MXSS	420	350
8	5/16	1/4-18	1/2-20	16	16	6	7	40	22	37	5-4 F6X-S	5-4F6MXSS	420	350
10	3/8	1/4-16	9/16-18	17	17	8	8	40	24	30	6 F6X-S	6F6MXSS	350	350
10	3/8	3/8-18	9/16-18	17	19	7	7	40	24	48	6-6 F6X-S	6-6F6MXSS	350	350
12	1/2	3/8-18	3/4-16	22	22	10	10	43	24	50	8 F6X-S	8F6MXSS	350	350
12	1/2	1/4-16	3/4-16	22	19	10	7	44	27	46	8-4F6MXS	8-4F6MXSS	350	350
12	1/2	1/2-14	3/4-16	22	22	10	10	50	28	69	8-8F6MXS	8-8F6MXSS	350	350
14, 15, 16	5/8	1/2-14	7/8-14	25	25	12	12	52	27	75	10 F6X-S	10F6MXSS	350	350
14, 15, 16	5/8	3/8-18	7/8-14	27	22	12	10	47	25	67	10-6F6MXS	10-6F6MXSS	350	350
18, 20	3/4	3/4-14	1 1/16-12	32	27	16	16	55	29	125	12F6MXS	12F6MXSS	350	350
18, 20	3/4	1/2-14	1 1/16-12	32	27	16	14	55	30	124	12-8F6MXS	12-8F6MXSS	350	350
25	1	1-11 1/2	1 5/16-12	38	36	22	22	64	48	204	16F6MXS	16F6MXSS	250	250
25	1	3/4-14	1 5/16-12	38	32	22	18	59	31	169	16-12F6MXS	16-12F6MXSS	250	250
28, 30, 32	1 1/4	1 1/4-11 1/2	1 5/8-12	50	46	28	28	70	38	496	20F6MXS	20F6MXSS	210	210
35, 38	1 1/2	1 1/2-11 1/2	1 7/8-12	58	58	34	34	78	43	750	24 F6X-S	24F6MXSS	170	170

Die angegebenen Artikel entsprechen unserem Standard-Lieferprogramm.
Zöllige und metrische Versionen können sich in der Schlüsselweite unterscheiden.

$$\frac{\text{PN (bar)}}{10} = \text{PN (MPa)}$$

Die angegebenen Nenndrücke PN beziehen sich auf die Stahl- und Edelstahlversion der Verschraubung.

F63MX Gerader Einschraubadapter

Triple-Lok® 37° Swivel, einstellbar / Zöll. (BSPT) Einschraubzapfen – kegelig (ISO 7)

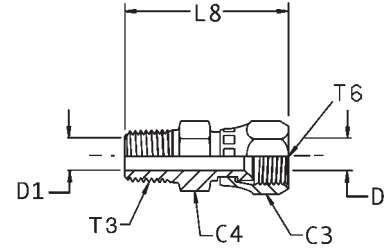

Rohr A.D. mm	Zoll	Gewinde BSPT T3	Gewinde UN/UNF-2B T6	C3 mm	C4 mm	D mm	D1 mm	L8 mm	Gewicht (Stahl) g/1 St.	Triple-Lok® Stahl	Triple-Lok® Edelstahl	PN (bar)	
												S	SS
6	1/4	1/8-28	7/16-20	16	13	4	4	34	18	4F63MXS	4F63MXSS	315	315
6	1/4	1/4-19	7/16-20	16	14	4	4	38	19	4-4F63MXS	4-4F63MXSS	315	315
8	5/16	1/4-19	1/2-20	17	14	6	6	39	37	5-4F63MXS	5-4F63MXSS	315	315
10	3/8	1/4-19	9/16-18	19	14	8	8	40	30	6F63MXS	6F63MXSS	315	315
10	3/8	3/8-19	9/16-18	19	19	8	8	41	48	6-6F63MXS	6-6F63MXSS	315	315
12	1/2	3/8-19	3/4-16	22	19	10	10	43	50	8F63MXS	8F63MXSS	315	315
12	1/2	1/4-19	3/4-16	22	19	10	7	41	46	8-4F63MXS	8-4F63MXSS	315	315
14, 15, 16	5/8	1/2-14	7/8-14	27	22	12	12	51	75	10F63MXS	10F63MXSS	315	315
14, 15, 16	5/8	3/8-19	7/8-14	27	22	12	10	46	67	10-6F63MXS	10-6F63MXSS	315	315
18, 20	3/4	3/4-14	1 1/16-12	32	27	16	16	55	125	12F63MXS	12F63MXSS	160	160
18, 20	3/4	1/2-14	1 1/16-12	32	27	16	14	55	120	12-8F63MXS	12-8F63MXSS	315	315
25	1	1-11	1 5/16-12	38	36	22	22	64	204	16F63MXS	16F63MXSS	160	160
25	1	3/4-14	1 5/16-12	38	32	22	18	59	165	16-12F63MXS	16-12F63MXSS	160	160
28, 30, 32	1 1/4	1 1/4-11	1 5/8-12	50	46	28	28	69	496	20F63MXS	20F63MXSS	160	160

Die angegebenen Artikel entsprechen unserem Standard-Lieferprogramm.
Zöllige und metrische Versionen können sich in der Schlüsselweite unterscheiden.

$$\frac{\text{PN (bar)}}{10} = \text{PN (MPa)}$$

Die angegebenen Nenndrücke PN beziehen sich auf die Stahl- und Edelstahlversion der Verschraubung.

K

C87OMX Winkel-Einschraubstutzen

Triple-Lok® 37° Bördelanschluss /
Metr. Einschraubzapfen, einstellbar – O-Ring (ISO 6149)

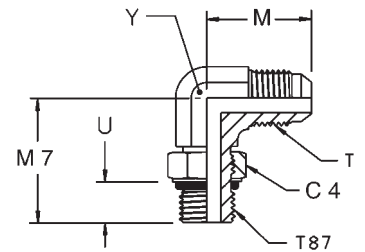

Rohr A.D.		Gewinde Metrisch T87	Gewinde UN/UNF-2A T	C4 mm	M mm	M7 mm	U mm	Y mm	Gewicht (Stahl) g/1 St.	Triple-Lok® Stahl	Triple-Lok® Edelstahl	PN (bar)	
mm	Zoll											S	SS
6	1/4	M10 × 1,0	7/16-20	14	23	27	9	11	17	4M10C87OMXS	4M10C87OMXSS	420	350
6	1/4	M12 × 1,5	7/16-20	17	24	31	11	13	20	4M12C87OMXS	4M12C87OMXSS	420	350
8	5/16	M10 × 1,0	1/2-20	14	24	26	9	13	22	5M10C87OMXS	5M10C87OMXSS	420	350
8	5/16	M12 × 1,5	1/2-20	17	24	31	11	13	25	5M12C87OMXS	5M12C87OMXSS	420	350
10	3/8	M14 × 1,5	9/16-18	19	27	34	11	14	31	6M14C87OMXS	6M14C87OMXSS	420	350
10	3/8	M16 × 1,5	9/16-18	22	29	38	12	19	55	6M16C87OMXS	6M16C87OMXSS	350	350
10	1/2	M16 × 1,5	3/4-16	22	32	38	12	19	65	8M16C87OMXS	8M16C87OMXSS	350	350
12	1/2	M18 × 1,5	3/4-16	24	32	38	13	19	66	8M18C87OMXS	8M18C87OMXSS	350	350
14, 15,16	5/8	M18 × 1,5	7/8-14	24	37	42	13	22	99	10M18C87OMXS	10M18C87OMXSS	350	350
14, 15,16	5/8	M22 × 1,5	7/8-14	27	37	43	13	22	99	10M22C87OMXS	10M22C87OMXSS	350	350
18, 20	3/4	M22 × 1,5	1 1/16-12	27	42	45	13	27	164	12M22C87OMXS	12M22C87OMXSS	350	350
18, 20	3/4	M27 × 2,0	1 1/16-12	32	42	50	16	27	173	12M27C87OMXS	12M27C87OMXSS	350	350
25	1	M27 × 2,0	1 5/16-12	32	46	53	16	33	287	16M27C87OMXS	16M27C87OMXSS	280	280
25	1	M33 × 2,0	1 5/16-12	41	46	53	16	33	287	16M33C87OMXS	16M33C87OMXSS	280	280
28, 30, 32	1 1/4	M42 × 2,0	1 5/8-12	50	52	58	16	41	575	20M42C87OMXS	20M42C87OMXSS	210	210
35, 38	1 1/2	M48 × 2,0	1 7/8-12	55	59	64	17	48	874	24M48C87OMXS	24M48C87OMXSS	140	140

Triple-Lok® Verschraubungen werden standardmäßig mit NBR Dichtung geliefert. Für alternative Dichtungswerkstoffe siehe Seite K93
Die angegebenen Artikel entsprechen unserem Standard-Lieferprogramm.
Zöllige und metrische Versionen können sich in der Schlüsselweite unterscheiden.

$$\frac{\text{PN (bar)}}{10} = \text{PN (MPa)}$$

Die angegebenen Nenndrücke PN beziehen sich auf die Stahl- und Edelstahlversion der Verschraubung.

C5OMX Winkel-Einschraubstutzen

Triple-Lok® 37° Bördelanschluss /
UN/UNF Einschraubzapfen, einstellbar – O-Ring (ISO 11926)
SAE 070220 MS51527

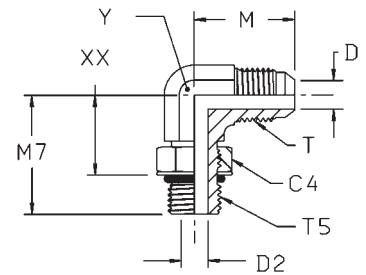

Rohr A.D. mm	Zoll	Gewinde UN/UNF-2A T5	Gewinde UN/UNF-2A T	C4 mm	D mm	D2 mm	M mm	M7 mm	XX mm	Y mm	Gewicht (Stahl) g/1 St.	Triple-Lok® Stahl	Triple-Lok® Edelstahl	PN (bar)	
														S	SS
6	1/8	5/16-24	5/16-24	11	2	2	20	24	15	11	25	2 C50X-S		350	—
	3/16	3/8-24	3/8-24	13	3	3	21	24	16	11	30	3 C50X-S		350	—
	1/4	7/16-20	7/16-20	14	4	4	23	26	16	11	37	4C50MXS	4C50MXSS	420	350
	6	1/4	9/16-18	7/16-20	17	4	8	27	32	21	43	4-6 C50X-S	4-6C50MXSS	420	350
8	5/16	1/2-20	1/2-20	16	6	6	24	29	18	13	47	5C50MXS	5C50MXSS	420	350
8	5/16	7/16-18	1/2-20	14	6	5	24	29	19	14	55	5-4 C50X-S	5-4C50MXSS	420	350
8	5/16	9/16-18	1/2-20	17	6	8	24	32	20	14	62	5-6 C50X-S	5-6C50MXSS	420	350
10	3/8	9/16-18	9/16-18	17	8	8	27	32	21	14	63	6C50MXS	6C50MXSS	420	350
10	3/8	7/16-20	9/16-18	14	8	4	27	30	20	14	99	6-4 C50X-S	6-4C50MXSS	420	350
10	3/8	1/2-20	9/16-18	16	8	6	27	30	18	14	99	6-5 C50X-S	6-5C50MXSS	420	350
10	3/8	3/4-16	9/16-18	22	8	10	29	37	24	19	125	6-8C50MXS	6-8C50MXSS	420	350
10	3/8	7/8-14	9/16-18	25	8	12	31	43	32	22	145	6-10 C50X-S	6-10C50MXSS	350	350
12	1/2	3/4-16	3/4-16	22	10	10	32	37	24	19	160	8C50MXS	8C50MXSS	420	350
12	1/2	7/8-14	3/4-16	14	10	5	32	32	22	19	150	8-4 C50X-S	8-4C50MXSS	420	350
12	1/2	9/16-18	3/4-16	17	10	8	32	34	23	19	130	8-6C50MXS	8-6C50MXSS	420	350
12	1/2	7/8-14	3/4-16	27	10	13	34	43	29	22	180	8-10C50MXS	8-10C50MXSS	350	350
12	1/2	1 1/16-12	3/4-16	32	10	16	36	49	33	27	210	8-12C50MXS	8-12C50MXSS	350	350
12	1/2	1 5/16-12	3/4-16	41	10	22	39	52	36	33	380	8-16 C50X-S	8-16C50MXSS	280	280
14, 15, 16	5/8	7/8-14	7/8-14	27	12	13	37	43	29	22	186	10C50MXS	10C50MXSS	350	350
14, 15, 16	5/8	9/16-18	7/8-14	18	13	8	37	36	25	22	130	10-6 C50X-S	10-6C50MXSS	350	350
14, 15, 16	5/8	3/4-16	7/8-14	22	12	10	37	39	27	22	157	10-8C50MXS	10-8C50MXSS	350	350
14, 15, 16	5/8	1 1/16-12	7/8-14	32	12	16	39	49	33	27	331	10-12C50MXS	10-12C50MXSS	350	350
14, 15, 16	5/8	1 5/16-12	7/8-14	41	13	22	42	52	36	33	400	10-16 C50X-S	10-16C50MXSS	280	280
18, 20	3/4	1 1/16-12	1 1/16-12	32	16	16	42	49	33	27	301	12C50MXS	12C50MXSS	350	350
18, 20	3/4	3/4-16	1 1/16-12	22	16	10	42	41	30	27	297	12-8 C50X-S	12-8C50MXSS	350	350
18, 20	3/4	7/8-14	1 1/16-12	27	16	13	42	45	31	27	297	12-10C50MXS	12-10C50MXSS	350	350
18, 20	3/4	1 3/16-12	1 1/16-12	35	16	18	45	51	34	33	350	12-14 C50X-S		280	—
18, 20	3/4	1 5/16-12	1 1/16-12	38	16	22	46	52	36	33	421	12-16 C50X-S	12-16C50MXSS	280	280
22	7/8	1 3/16-12	1 3/16-12	35	18	18	44	51	34	33	417	14 C50X-S		280	—
25	1	1 5/16-12	1 5/16-12	38	22	22	46	52	36	33	426	16C50MXS	16C50MXSS	280	280
25	1	1 1/16-12	1 5/16-12	32	22	16	46	52	36	33	418	16-12C50MXS	16-12C50MXSS	280	280
25	1	1 3/16-12	1 5/16-12	35	22	18	46	53	36	33	450	16-14 C50X-S		280	—
25	1	1 5/8-12	1 5/16-12	48	22	28	51	57	41	41	546	16-20 C50X-S	16-20C50MXSS	280	210
25	1	1 7/8-12	1 5/16-12	55	22	34	55	61	44	48	600	16-24 C50X-S	16-24C50MXSS	210	210
28, 30, 32	1 1/4	1 5/8-12	1 5/8-12	50	28	28	52	57	41	41	674	20C50MXS	20C50MXSS	280	210
28, 30, 32	1 1/4	1 5/16-12	1 5/8-12	41	28	22	52	57	41	41	650	20-16 C50X-S	20-16C50MXSS	280	280
28, 30, 32	1 1/4	1 7/8-12	1 5/8-12	55	28	34	56	61	44	48	920	20-24 C50X-S	20-24C50MXSS	210	210
35, 38	1 1/2	1 7/8-12	1 7/8-12	55	33	33	59	61	44	48	917	24 C50X-S	24C50MXSS	210	140
35, 38	1 1/2	1 5/8-12	1 7/8-12	48	34	28	59	61	44	48	920	24-20 C50X-S	24-20C50MXSS	210	140

Triple-Lok® Verschraubungen werden standardmäßig mit NBR Dichtung geliefert. Für alternative Dichtungswerkstoffe siehe Seite K93

Die angegebenen Artikel entsprechen unserem Standard-Lieferprogramm.

Zöllige und metrische Versionen können sich in der Schlüsselweite unterscheiden.

$$\frac{\text{PN (bar)}}{10} = \text{PN (MPa)}$$

Die angegebenen Nenndrücke PN beziehen sich auf die Stahl- und Edelstahlversion der Verschraubung.

CC50X Winkel-Einschraubstutzen mit langem Schaft

Triple-Lok® 37° Bördelanschluss / UN/UNF Einschraubzapfen – O-Ring (ISO 11926)

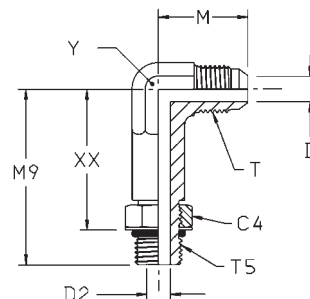

Rohr A.D.	Gewinde UN/UNF-2A T5	Gewinde UN/UNF-2A T	C4 mm	D mm	D2 mm	M mm	M9 mm	XX mm	Y mm	Gewicht (Stahl) g/1 St.	Triple-Lok® Stahl	PN (bar)
6	1/4	7/16-20	14	4	4	25	44	34	14	44	4 CC50X-S	420
10	3/8	9/16-18	18	8	8	27	53	42	14	51	6 CC50X-S	420
12	1/2	3/4-16	22	10	10	32	64	51	22	146	8 CC50X-S	420
14, 15, 16	5/8	7/8-14	25	12	12	37	73	59	22	169	10 CC50X-S	350
18, 20	3/4	1 1/16-12	32	16	16	42	85	68	27	291	12 CC50X-S	350
25	1	1 5/16-12	38	21	21	46	95	78	33	481	16 CC50X-S	280

Triple-Lok® Verschraubungen werden standardmäßig mit NBR Dichtung geliefert. Für alternative Dichtungswerkstoffe siehe Seite K93

Die angegebenen Artikel entsprechen unserem Standard-Lieferprogramm.

Zöllige und metrische Versionen können sich in der Schlüsselweite unterscheiden.

$$\frac{\text{PN (bar)}}{10} = \text{PN (MPa)}$$

C4OMX Winkel-Einschraubstutzen

Triple-Lok® 37° Bördelanschluss /
Zöll. Einschraubzapfen, einstellbar – O-Ring + Kammerring (ISO 1179)

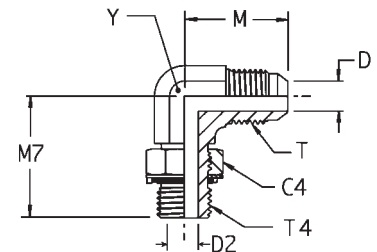

Rohr A.D.	Zoll	Gewinde BSPP T4	Gewinde UN/UNF-2A T	C4 mm	D mm	D2 mm	M mm	M7 mm	Y mm	Gewicht (Stahl) g/1 St.	Triple-Lok® Stahl	Triple-Lok® Edelstahl	PN (bar)	
													S	SS
6	1/4	1/8-28	7/16-20	14	4	4	23	27	11	37	4C4OMXS	4C4OMXS	250	250
6	1/4	1/4-19	7/16-20	19	4	8	27	32	14	43	4-4C4OMXS	4-4C4OMXS	250	200
6	1/4	3/8-19	7/16-20	22	4	10	29	37	19	50	4-6C4OMXS	4-6C4OMXS	250	200
8	5/16	1/8-28	1/2-20	14	6	4	24	27	13	47	5C4OMXS	5C4OMXS	250	250
8	5/16	1/4-19	1/2-20	19	6	8	27	32	14	55	5-4C4OMXS	5-4C4OMXS	250	200
8	5/16	3/8-19	1/2-20	22	6	10	29	37	19	57	5-6C4OMXS	5-6C4OMXS	250	200
10	3/8	1/4-19	9/16-18	19	8	8	27	32	14	61	6C4OMXS	6C4OMXS	250	200
10	3/8	1/8-28	9/16-18	14	8	4	27	28	14	52	6-2C4OMXS	6-2C4OMXS	250	200
10	3/8	3/8-19	9/16-18	22	8	10	29	37	19	95	6-6C4OMXS	6-6C4OMXS	250	200
10	3/8	1/2-14	9/16-18	27	8	12	31	43	22	80	6-8C4OMXS	6-8C4OMXS	250	200
12	1/2	3/8-19	3/4-16	22	10	10	32	37	19	102	8C4OMXS	8C4OMXS	250	200
12	1/2	1/4-19	3/4-16	19	10	8	32	37	19	91	8-4C4OMXS	8-4C4OMXS	250	200
12	1/2	1/2-14	3/4-16	27	10	12	34	43	22	155	8-8C4OMXS	8-8C4OMXS	250	200
12	1/2	3/4-14	3/4-16	36	10	16	36	50	27	205	8-12C4OMXS	8-12C4OMXS	250	200
14, 15, 16	5/8	1/2-14	7/8-14	27	12	12	37	43	22	164	10C4OMXS	10C4OMXS	250	200
14, 15, 16	5/8	3/8-19	7/8-14	22	12	10	37	36	22	190	10-6C4OMXS	10-6C4OMXS	250	200
14, 15, 16	5/8	3/4-14	7/8-14	36	12	16	39	50	27	217	10-12C4OMXS	10-12C4OMXS	250	200
18, 20	3/4	3/4-14	1 1/16-12	36	16	16	42	50	27	295	12C4OMXS	12C4OMXS	250	200
18, 20	3/4	1/2-14	1 1/16-12	27	16	12	42	50	27	245	12-8C4OMXS	12-8C4OMXS	250	200
18, 20	3/4	1-11	1 1/16-12	41	16	22	45	52	33	317	12-16C4OMXS	12-16C4OMXS	250	200
25	1	1-11	1 5/16-12	41	22	22	46	52	33	425	16C4OMXS	16C4OMXS	250	200
25	1	3/4-14	1 5/16-12	36	22	16	46	47	33	405	16-12C4OMXS	16-12C4OMXS	250	200
28, 30, 32	1 1/4	1 1/4-11	1 5/8-12	50	28	28	52	57	41	697	20C4OMXS	20C4OMXS	210	160
28, 30, 32	1 1/4	1-11	1 5/8-12	41	28	22	52	57	41	650	20-16C4OMXS	20-16C4OMXS	250	160
35, 38	1 1/2	1 1/2-11	1 7/8-12	55	33	33	59	61	48	953	24C4OMXS	24C4OMXS	140	140
35, 38	1 1/2	1 1/4-11	1 7/8-12	50	33	28	59	61	48	964	24-20C4OMXS	24-20C4OMXS	210	140

Triple-Lok® Verschraubungen werden standardmäßig mit NBR Dichtung geliefert. Für alternative Dichtungswerkstoffe siehe Seite K93

Die angegebenen Artikel entsprechen unserem Standard-Lieferprogramm.

Zöllige und metrische Versionen können sich in der Schlüsselweite unterscheiden.

$$\frac{\text{PN (bar)}}{10} = \text{PN (MPa)}$$

Die angegebenen Nenndrücke PN beziehen sich auf die Stahl- und Edelstahlversion der Verschraubung.

C8OMX Winkel-Einschraubstutzen

Triple-Lok® 37° Bördelanschluss / Metr. Einschraubzapfen – O-Ring + Kammerring

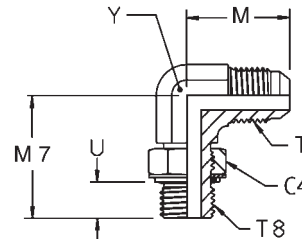

Rohr A.D. mm	Zoll	Gewinde Metrisch T8	Gewinde UN/UNF-2A T	M mm	Y mm	U mm	C4 mm	M7 mm	Gewicht (Stahl) g/1 St.	Triple-Lok® Stahl	PN (bar)
6	1/4	M10 × 1,0	7/16-20	23	11	8	13	27	23	4M10C8OMXS	250
6	1/4	M12 × 1,5	7/16-20	24	13	10	17	31	28	4M12C8OMXS	250
8	5/16	M10 × 1,0	1/2-20	24	13	8	13	26	29	5M10C8OMXS	250
8	5/16	M12 × 1,5	1/2-20	24	13	10	17	31	29	5M12C8OMXS	250
10	3/8	M14 × 1,5	9/16-18	27	14	10	17	34	36	6M14C8OMXS	250
10	3/8	M16 × 1,5	9/16-18	29	19	10	19	38	74	6M16C8OMXS	250
12	1/2	M16 × 1,5	3/4-16	32	19	10	19	38	77	8M16C8OMXS	250
12	1/2	M18 × 1,5	3/4-16	32	19	11	22	38	78	8M18C8OMXS	250
14, 15,16	5/8	M18 × 1,5	7/8-14	37	22	11	22	42	104	10M18C8OMXS	250
14, 15,16	5/8	M20 × 1,5	7/8-14	37	22	11	24	41	110	10M20C8OMXS	250
14, 15,16	5/8	M22 × 1,5	7/8-14	37	22	12	27	43	119	10M22C8OMXS	250
18, 20	3/4	M22 × 1,5	1 1/16-12	42	27	12	27	45	198	12M22C8OMXS	250
18, 20	3/4	M27 × 2,0	1 1/16-12	42	27	14	32	50	208	12M27C8OMXS	175
25	1	M27 × 2,0	1 5/16-12	46	33	14	32	53	333	16M27C8OMXS	175
25	1	M33 × 2,0	1 5/16-12	46	33	14	38	53	333	16M33C8OMXS	140
28, 30, 32	1 1/4	M42 × 2,0	1 5/8-12	52	41	14	50	58	575	20M42C8OMXS	140
35, 38	1 1/2	M48 × 2,0	1 7/8-12	59	48	15	55	64	872	24M48C8OMXS	140

Triple-Lok® Verschraubungen werden standardmäßig mit NBR Dichtung geliefert. Für alternative Dichtungswerkstoffe siehe Seite K93

Die angegebenen Artikel entsprechen unserem Standard-Lieferprogramm.

Zöllige und metrische Versionen können sich in der Schlüsselweite unterscheiden.

$$\frac{\text{PN (bar)}}{10} = \text{PN (MPa)}$$

CMTX Winkel-Einschraubstutzen

Triple-Lok® 37° Bördelanschluss / NPTF* Einschraubzapfen (SAE J476)

SAE 070202 MS51504

*Edelstahl = NPT Gewinde

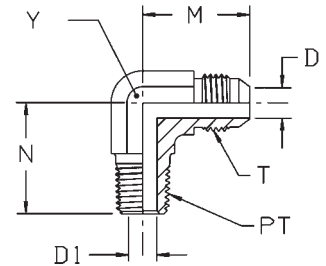

Rohr A.D.	Gewinde NPT/NPTF PT	Gewinde UN/UNF-2A T	D mm	D1 mm	M mm	N mm	Y mm	Gewicht (Stahl) g/1 St.	Triple-Lok® Stahl	Triple-Lok® Edelstahl	PN (bar)		
											S	SS	
6	1/8	1/8-27	5/16-24	2	5	20	18	8	12	2 CTX-S		420	—
	3/16	1/8-27	3/8-24	3	5	21	18	10	15	3 CTX-S		420	—
	1/4	1/8-27	7/16-20	4	5	23	20	11	23	4CMTXS	4CMTXSS	420	350
	1/4	1/4-18	7/16-20	4	7	27	28	14	42	4-4CMTXS	4-4CMTXSS	420	350
	1/4	3/8-18	7/16-20	4	10	29	31	19	26	4-6 CTX-S	4-6CMTXSS	420	350
8	1/4	1/2-14	7/16-20	4	14	31	37	22	30	4-8 CTX-S	4-8CMTXSS	420	350
	5/16	1/8-27	1/2-20	6	5	24	20	13	29	5CMTXS	5CMTXSS	420	350
	5/16	1/4-18	1/2-20	6	7	27	28	14	42	5-4CMTXS	5-4CMTXSS	420	350
	5/16	3/8-18	1/2-20	6	10	29	31	19	45	5-6 CTX-S	5-6CMTXSS	420	350
	3/8	1/4-16	9/16-18	8	7	27	28	14	45	6CMTXS	6CMTXSS	420	350
10	3/8	1/8-27	9/16-18	8	5	27	23	14	55	6-2CMTXS	6-2CMTXSS	420	350
	3/8	3/8-18	9/16-18	8	10	29	31	19	76	6-6CMTXS	6-6CMTXSS	420	350
	3/8	1/2-14	9/16-18	8	14	31	37	22	117	6-8CMTXS	6-8CMTXSS	420	350
	1/2	3/8-18	3/4-16	10	10	32	31	19	86	8CMTXS	8CMTXSS	420	350
	1/2	1/4-16	3/4-16	10	7	32	31	19	82	8-4CMTXS	8-4CMTXSS	420	350
12	1/2	1/2-14	3/4-16	10	14	34	37	22	125	8-8CMTXS	8-8CMTXSS	420	350
	1/2	3/4-14	3/4-16	10	18	36	40	27	190	8-12 CTX-S	8-12CMTXSS	280	280
	5/8	1/2-14	7/8-14	12	14	37	37	22	129	10CMTXS	10CMTXSS	350	350
	5/8	3/8-18	7/8-14	12	10	37	33	22	127	10-6 CTX-S	10-6CMTXSS	350	350
	5/8	3/4-14	7/8-14	12	18	39	40	27	192	10-12CMTXS	10-12CMTXSS	280	280
14, 15, 16	3/4	3/4-14	1 1/16-12	16	18	42	40	27	198	12CMTXS	12CMTXSS	280	280
	3/4	1/2-14	1 1/16-12	16	14	42	40	27	204	12-8 CTX-S	12-8CMTXSS	350	350
	3/4	1-11 1/2	1 1/16-12	16	24	45	50	33	318	12-16CMTXS	12-16CMTXSS	210	210
	7/8	3/4-14	1 3/16-12	18	18	46	43	31	260	14 CTX-S	14CMTXSS	280	245
	1	1-11 1/2	1 5/16-12	22	24	46	50	33	328	16CMTXS	16CMTXSS	210	210
18, 20	1	3/4-14	1 5/16-12	22	18	46	45	33	318	16-12 CTX-S	16-12CMTXSS	280	280
	1	1 1/4-11 1/2	1 5/16-12	22	32	54	61	45	477	16-20 CTX-S	16-20CMTXSS	170	170
	1 1/4	1 1/4-11 1/2	1 5/8-12	28	32	52	61	45	549	20 CTX-S	20CMTXSS	170	170
	1 1/4	1-11 1/2	1 5/8-12	28	24	52	60	41	536	20-16CMTXS	20-16CMTXSS	210	210
	1 1/4	1 1/2-11 1/2	1 7/8-12	28	38	56	67	48	630	20-24 CTX-S	20-24CMTXSS	170	140
28, 30, 32	1 1/2	1 1/2-11 1/2	1 7/8-12	33	38	59	67	48	747	24 CTX-S	24CMTXSS	170	140
	1 1/2	1 1/4-11 1/2	1 7/8-12	33	32	59	57	48	715	24-20 CTX-S	24-20CMTXSS	170	140
	2	2-11/12	2 1/2-12	45	49	78	76	64	1644	32 CTX-S		140	—
	2	1 1/2-11 1/2	2 1/2-12	45	38	78	75	66	1450	32-24 CTX-S		140	—

Die angegebenen Artikel entsprechen unserem Standard-Lieferprogramm.
Zöllige und metrische Versionen können sich in der Schlüsselweite unterscheiden.

$$\frac{\text{PN (bar)}}{10} = \text{PN (MPa)}$$

Die angegebenen Nenndrücke PN beziehen sich auf die Stahl- und Edelstahlversion der Verschraubung.

CCTX Winkel-Einschraubstutzen mit langem Schaft

Triple-Lok® 37° Bördelanschluss / NPTF* Einschraubzapfen (SAE J476)

SAE 070202 MS51504

*Edelstahl = NPT Gewinde

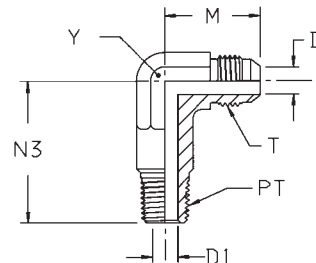

Rohr A.D.		Gewinde NPT/NPTF PT	Gewinde UN/UNF-2A T	D mm	D1 mm	M mm	N3 mm	Y mm	Gewicht (Stahl) g/1 St.	Triple-Lok® Stahl	Triple-Lok® Edelstahl	PN (bar)	
mm	Zoll											S	SS
6	1/4	1/8-27	7/16-20	5	5	23	30	11	28	4 CCTX-S	4 CCTX-SS	420	350
6	1/4	1/4-18	7/16-20	5	7	27	37	14	28	4-4 CCTX-S	4-4 CCTX-SS	420	350
8	5/16	1/8-27	1/2-20	6	5	24	30	14	35	5 CCTX-S	5 CCTX-SS	420	350
10	3/8	1/4-16	9/16-18	8	7	27	40	14	58	6 CCTX-S	6 CCTX-SS	420	350
10	3/8	3/8-18	9/16-18	8	11	29	46	19	58	6-6 CCTX-S	6-6 CCTX-SS	420	350
12	1/2	3/8-18	3/4-16	10	10	32	45	19	111	8 CCTX-S	8 CCTX-SS	420	350
12	1/2	1/2-14	3/4-16	10	14	34	55	22	136	8-8 CCTX-S	8-8 CCTX-SS	420	350
14, 15, 16	5/8	1/2-14	7/8-14	13	14	37	55	22	183	10 CCTX-S	10 CCTX-SS	350	350
18, 20	3/4	3/4-14	1 1/16-12	16	18	42	61	27	253	12 CCTX-S	12 CCTX-SS	280	280
25	1	1-11 1/2	1 5/16-12	21	24	46	76	33	435	16 CCTX-S	16 CCTX-SS	210	210
28, 30, 32	1 1/4	1 1/4-11 1/2	1 5/8-12	28	32	52	93	41	1021	20 CCTX-S	20 CCTX-SS	170	170

Die angegebenen Artikel entsprechen unserem Standard-Lieferprogramm.
Zöllige und metrische Versionen können sich in der Schlüsselweite unterscheiden.

$$\frac{\text{PN (bar)}}{10} = \text{PN (MPa)}$$

Die angegebenen Nenndrücke PN beziehen sich auf die Stahl- und Edelstahlversion der Verschraubung.

CCCTX Winkel-Einschraubstutzen mit extra langem Schaft

Triple-Lok® 37° Bördelanschluss / NPTF* Einschraubzapfen (SAE J476)
SAE 071602

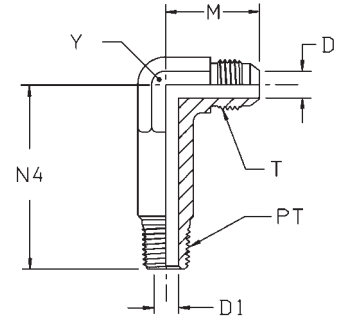

Rohr A.D. mm	Zoll	Gewinde NPT/NPTF PT	Gewinde UN/UNF-2A T	D mm	D1 mm	M mm	N4 mm	Y mm	Gewicht (Stahl) g/1 St.	Triple-Lok® Stahl	PN (bar)
6	1/4	1/8-27	7/16-20	5	5	23	40	11	32	4 CCCTX-S	420
6	1/4	1/4-18	7/16-20	5	7	27	52	14	32	4-4 CCCTX-S	420
8	5/16	1/8-27	1/2-20	6	5	25	41	14	39	5 CCCTX-S	420
10	3/8	1/4-16	9/16-18	8	7	27	53	14	72	6 CCCTX-S	420
10	3/8	3/8-18	9/16-18	8	11	29	59	19	72	6-6 CCCTX-S	420
12	1/2	3/8-18	3/4-16	10	10	32	59	19	130	8 CCCTX-S	420
12	1/2	1/2-14	3/4-16	10	14	34	72	22	163	8-8 CCCTX-S	420
14, 15, 16	5/8	1/2-14	7/8-14	13	14	37	72	22	212	10 CCCTX-S	350
18, 20	3/4	3/4-14	1 1/16-12	16	18	42	82	27	356	12 CCCTX-S	280
25	1	1-11 1/2	1 5/16-12	21	24	46	101	33	520	16 CCCTX-S	210
28, 30, 32	1 1/4	1 1/4-11 1/2	1 5/8-12	28	32	52	126	41	1196	20 CCCTX-S	170

Die angegebenen Artikel entsprechen unserem Standard-Lieferprogramm.
Zöllige und metrische Versionen können sich in der Schlüsselweite unterscheiden.

$$\frac{\text{PN (bar)}}{10} = \text{PN (MPa)}$$

K

C3MX Winkel-Einschraubstutzen

Triple-Lok® 37° Bördelanschluss / Zöll. (BSPT) Einschraubzapfen – kegelig (ISO 7)

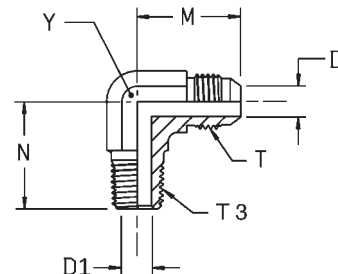

Rohr A.D.		Gewinde BSPT T3	Gewinde UN/UNF-2A T	D mm	D1 mm	M mm	N mm	Y mm	Gewicht (Stahl) g/1 St.	Triple-Lok® Stahl	Triple-Lok® Edelstahl	PN (bar)	
mm	Zoll											S	SS
6	1/4	1/8-28	7/16-20	4	5	23	20	11	23	4C3MXS	4C3MXSS	315	315
6	1/4	1/4-19	7/16-20	4	7	27	28	14	42	4-4C3MXS	4-4C3MXSS	315	315
8	5/16	1/8-28	1/2-20	6	5	24	20	13	29	5C3MXS	5C3MXSS	315	315
8	5/16	1/4-19	1/2-20	6	7	27	28	14	42	5-4C3MXS	5-4C3MXSS	315	315
10	3/8	1/4-19	9/16-18	8	7	27	28	14	45	6C3MXS	6C3MXSS	315	315
10	3/8	3/8-19	9/16-18	8	10	29	31	19	76	6-6C3MXS	6-6C3MXSS	315	315
10	3/8	1/2-14	9/16-18	8	14	31	37	22	117	6-8C3MXS	6-8C3MXSS	315	315
12	1/2	3/8-19	3/4-16	10	10	32	31	19	86	8C3MXS	8C3MXSS	315	315
12	1/2	1/4-19	3/4-16	10	7	32	31	19	82	8-4C3MXS	8-4C3MXSS	315	315
12	1/2	1/2-14	3/4-16	10	14	34	37	22	125	8-8C3MXS	8-8C3MXSS	315	315
14, 15,16	5/8	1/2-14	7/8-14	12	14	37	37	22	129	10C3MXS	10C3MXSS	315	315
14, 15,16	5/8	3/8-19	7/8-14	12	10	37	33	22	127	10-6C3MXS	10-6C3MXSS	315	315
14, 15,16	5/8	3/4-14	7/8-14	12	18	39	40	27	192	10-12C3MXS	10-12C3MXSS	160	160
18, 20	3/4	3/4-14	1 1/16-12	16	18	42	40	27	198	12C3MXS	12C3MXSS	160	160
18, 20	3/4	1/2-14	1 1/16-12	16	14	42	40	27	204	12-8C3MXS	12-8C3MXSS	315	315
18, 20	3/4	1-11	1 1/16-12	16	24	45	50	33	251	12-16C3MXS	12-16C3MXSS	160	160
25	1	1-11	1 5/16-12	22	24	46	50	33	328	16C3MXS	16C3MXSS	160	160
25	1	3/4-14	1 5/16-12	22	18	46	45	33	318	16-12C3MXS	16-12C3MXSS	160	160
28, 30, 32	1 1/4	1 1/4-11	1 5/8-12	28	32	52	61	41	549	20C3MXS	20C3MXSS	160	160
28, 30, 32	1 1/4	1-11	1 5/8-12	28	24	52	60	41	536	20-16C3MXS	20-16C3MXSS	160	160
35, 38	1 1/2	1 1/2-11	1 7/8-12	33	38	59	67	48	747	24C3MXS	24C3MXSS	160	140

Die angegebenen Artikel entsprechen unserem Standard-Lieferprogramm.
Zöllige und metrische Versionen können sich in der Schlüsselweite unterscheiden.

$$\frac{\text{PN (bar)}}{10} = \text{PN (MPa)}$$

Die angegebenen Nenndrücke PN beziehen sich auf die Stahl- und Edelstahlversion der Verschraubung.

V87OMX 45° Einschraubstutzen

Triple-Lok® 37° Bördelanschluss / Metr. Einschraubzapfen – O-Ring (ISO 6149)

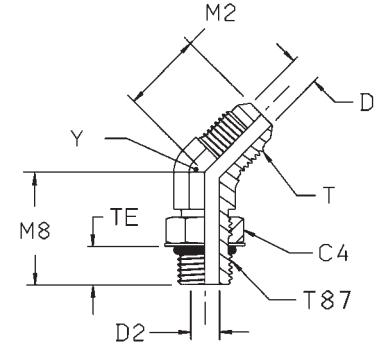

Rohr A.D.	Gewinde Metrisch T87	Gewinde UN/UNF-2A T	C4 mm	D mm	D2 mm	M2 mm	M8 mm	TE mm	Y mm	Gewicht (Stahl) g/1 St.	Triple-Lok® Stahl	PN (bar)	
6	1/4	M10 × 1,0	7/16-20	14	4	5	18	27	9	11	17	4M10V87OMXS	420
4	1/4	M12 × 1,0	7/16-20	17	4	6	20	28	11	13	25	4M12V87OMXS	420
8	5/16	M10 × 1,0	1/2-20	14	6	5	18	27	9	13	31	5M10V87OMXS	420
8	5/16	M12 × 1,5	1/2-20	17	6	6	20	28	11	13	25	5M12V87OMXS	420
10	3/8	M14 × 1,5	9/16-18	19	8	8	21	28	11	14	31	6M14V87OMXS	420
10	3/8	M16 × 1,5	9/16-18	22	8	9	22	32	12	19	58	6M16V87OMXS	350
10	3/8	M18 × 1,5	9/16-18	24	8	11	22	33	13	19	66	6M18V87OMXS	350
12	1/2	M16 × 1,5	3/4-16	22	10	9	25	33	12	19	65	8M16V87OMXS	350
12	1/2	M18 × 1,5	3/4-16	24	10	11	25	33	13	19	66	8M18V87OMXS	350
14, 15, 16	5/8	M18 × 1,5	7/8-14	24	12	11	28	37	13	22	99	10M18V87OMXS	350
14, 15, 16	5/8	M22 × 1,5	7/8-14	27	12	14	28	38	13	22	99	10M22V87OMXS	350
18, 20	3/4	M22 × 1,5	1 1/16-12	27	16	14	33	40	13	27	164	12M22V87OMXS	350
18, 20	3/4	M27 × 2,0	1 1/16-12	32	16	18	33	46	16	27	173	12M27V87OMXS	350
25	1	M33 × 2,0	1 5/16-12	41	22	23	37	46	16	33	287	16M33V87OMXS	280

Triple-Lok® Verschraubungen werden standardmäßig mit NBR Dichtung geliefert. Für alternative Dichtungswerkstoffe siehe Seite K93

Die angegebenen Artikel entsprechen unserem Standard-Lieferprogramm.

Zöllige und metrische Versionen können sich in der Schlüsselweite unterscheiden.

$$\frac{\text{PN (bar)}}{10} = \text{PN (MPa)}$$

K

V5OMX 45° Einschraubstutzen

Triple-Lok® 37° Bördelanschluss / UN/UNF Einschraubzapfen – O-Ring (ISO 11926)
SAE 070320 MS51528

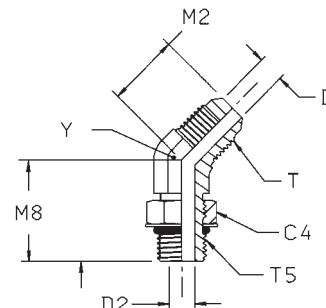

Rohr A.D.		Gewinde UN/UNF-2A T5	Gewinde UN/UNF-2A T	C4	D	D2	M2	M8	Y	Gewicht (Stahl) g/1 St.	Triple-Lok® Stahl	Triple-Lok® Edelstahl	PN (bar)	
mm	in.			mm	mm	mm	mm	mm	mm				S	SS
6	1/4	7/16-20	7/16-20	14	4	5	18	27	11	34	4V5OMXS	4 V50X-SS	420	350
8	5/16	1/2-20	1/2-20	16	6	6	20	27	13	42	5V5OMXS	5 V50X-SS	420	350
10	3/8	9/16-18	9/16-18	17	8	8	21	29	14	52	6V5OMXS	6 V50X-SS	420	350
10	3/8	3/4-16	9/16-19	22	8	10	22	33	19	104	6-8 V50X-S	6-8 V50X-SS	420	350
12	1/2	3/4-16	3/4-16	22	10	10	25	33	19	104	8V5OMXS	8 V50X-SS	420	350
12	1/2	9/16-18	3/4-16	17	10	8	25	30	19	98	8-6V5OMXS	8-6 V50X-SS	420	350
12	1/2	7/8-14	3/4-16	25	10	12	25	39	22	148	8-10 V50X-S	8-10 V50X-SS	350	350
14, 15,16	5/8	7/8-14	7/8-14	27	12	13	28	39	22	157	10V5OMXS	10 V50X-SS	350	350
14, 15,16	5/8	3/4-16	7/8-14	22	12	10	28	35	22	157	10-8V5OMXS	10-8 V50X-SS	350	350
18, 20	3/4	1 1/16-12	1 1/16-12	32	16	16	33	44	27	258	12V5OMXS	12 V50X-SS	350	350
18, 20	3/4	7/8-14	1 1/16-12	25	16	12	33	40	27	227	12-10 V50X-S	12-10 V50X-SS	350	350
22	7/8	1 3/16-12	1 3/16-12	35	18	18	37	47	33	275	14 V50X-S		280	—
25	1	1 5/16-12	1 5/16-12	38	22	22	37	47	33	375	16V5OMXS	16 V50X-SS	280	280
28, 30, 32	1 1/4	1 5/8-12	1 5/8-12	48	28	28	40	49	41	570	20 V50X-S	20 V50X-SS	280	210
35, 38	1 1/2	1 7/8-12	1 7/8-12	54	33	33	45	49	48	706	24 V50X-S	24 V50X-SS	210	140

Triple-Lok® Verschraubungen werden standardmäßig mit NBR Dichtung geliefert. Für alternative Dichtungswerkstoffe siehe Seite K93
Die angegebenen Artikel entsprechen unserem Standard-Lieferprogramm.
Zöllige und metrische Versionen können sich in der Schlüsselweite unterscheiden.

$$\frac{\text{PN (bar)}}{10} = \text{PN (MPa)}$$

Die angegebenen Nenndrücke PN beziehen sich auf die Stahl- und Edelstahlversion der Verschraubung.

V4OMX 45° Einschraubstutzen

Triple-Lok® 37° Bördelanschluss / Zöll. Einschraubzapfen – O-Ring + Kammerring (ISO 1179)

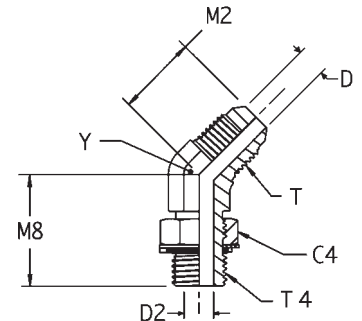

Rohr A.D.	Gewinde BSPP T4	Gewinde UN/UNF-2A T	C4 mm	D mm	D2 mm	M2 mm	M8 mm	Y mm	Gewicht (Stahl) g/1 St.	Triple-Lok® Stahl	PN (bar)
6	1/8-28	7/16-20	14	4	4	18	27	11	35	4V4OMXS	250
6	1/4-19	7/16-20	19	4	8	21	29	14	48	4-4V4OMXS	250
8	1/8-28	1/2-20	14	6	4	20	27	13	44	5V4OMXS	250
8	1/4-19	1/2-20	19	6	8	21	27	14	51	5-4V4OMXS	250
10	1/4-19	9/16-18	19	8	8	21	29	14	55	6V4OMXS	250
10	3/8-19	9/16-18	22	8	10	22	33	19	70	6-6V4OMXS	250
10	1/2-14	9/16-18	27	8	12	22	39	22	92	6-8V4OMXS	250
12	3/8-19	3/4-16	22	10	10	25	33	19	104	8V4OMXS	250
12	1/2-14	3/4-16	27	10	12	25	39	22	148	8-8V4OMXS	250
14, 15, 16	1/2-14	7/8-14	27	10	12	28	39	22	165	10V4OMXS	250
14, 15, 16	3/4-14	7/8-14	36	12	16	30	44	27	235	10-12V4OMXS	250
18, 20	3/4-14	1 1/16-12	36	16	16	33	44	27	270	12V4OMXS	250
25	1-11	1 5/16-12	41	22	22	37	47	33	394	16V4OMXS	250
28, 30, 32	1 1/4-11	1 5/8-12	50	28	28	40	48	41	599	20V4OMXS	210
35, 38	1 1/2-11	1 7/8-12	55	33	33	45	48	48	750	24V4OMXS	140

Triple-Lok® Verschraubungen werden standardmäßig mit NBR Dichtung geliefert. Für alternative Dichtungswerkstoffe siehe Seite K93
Die angegebenen Artikel entsprechen unserem Standard-Lieferprogramm.
Zöllige und metrische Versionen können sich in der Schlüsselweite unterscheiden.

$$\frac{\text{PN (bar)}}{10} = \text{PN (MPa)}$$

K

V8OMX 45° Einschraubstutzen

Triple-Lok® 37° Bördelanschluss / Metr. Einschraubzapfen – O-Ring + Kammerring

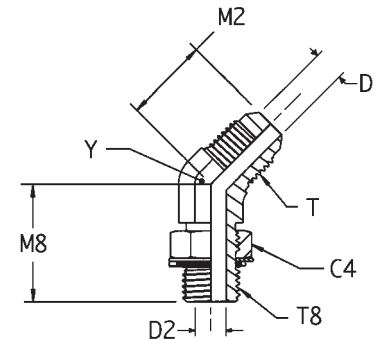

Rohr A.D.		Gewinde Metrisch T8	Gewinde UN/UNF-2A T	C4 mm	D mm	D2 mm	M2 mm	M8 mm	Y mm	Gewicht (Stahl) g/1 St.	Triple-Lok® Stahl	PN (bar)
mm	Zoll											
6	1/4	M10 × 1,0	7/16-20	13	4	5	18	27	11	23	4M10V8OMXS	250
6	1/4	M12 × 1,5	7/16-20	17	4	6	20	27	13	25	4M12V8OMXS	250
8	5/16	M12 × 1,5	1/2-20	17	6	6	20	28	13	28	5M12V8OMXS	250
10	3/8	M14 × 1,5	9/16-18	17	8	8	21	28	14	36	6M14V8OMXS	250
12	1/2	M16 × 1,5	3/4-16	19	10	9	25	33	19	68	8M16V8OMXS	250
12	1/2	M18 × 1,5	3/4-16	22	10	11	25	33	19	78	8M18V8OMXS	250
14, 15, 16	5/8	M22 × 1,5	7/8-14	27	12	14	28	38	22	119	10M22V8OMXS	250
18, 20	3/4	M27 × 2,0	1 1/16-12	32	16	18	33	46	27	208	12M27V8OMXS	175
25	1	M33 × 2,0	1 5/16-12	38	22	23	37	46	33	333	16M33V8OMXS	140

Triple-Lok® Verschraubungen werden standardmäßig mit NBR Dichtung geliefert. Für alternative Dichtungswerkstoffe siehe Seite K93
Die angegebenen Artikel entsprechen unserem Standard-Lieferprogramm.
Zöllige und metrische Versionen können sich in der Schlüsselweite unterscheiden.

$$\frac{\text{PN (bar)}}{10} = \text{PN (MPa)}$$

VMTX 45° Einschraubstutzen

Triple-Lok® 37° Bördelanschluss / NPTF* Einschraubzapfen (SAE J476)

SAE 070302 MS51508

*Edelstahl = NPT Gewinde

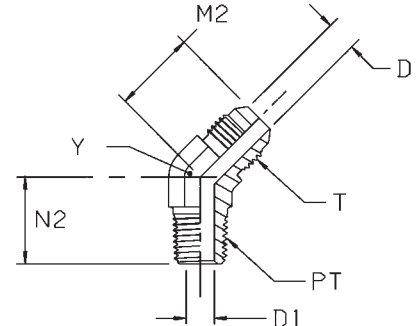

Rohr A.D.	mm	Zoll	Gewinde NPT/NPTF PT	Gewinde UN/UNF-2A T	D mm	D1 mm	M2 mm	N2 mm	Y mm	Gewicht (Stahl) g/1 St.	Triple-Lok®			PN (bar)	
											Stahl	Edelstahl	Messing	S	SS
6	3/16	1/4	1/8-27	3/8-24	3	5	18	14	11	15	3 VTX-S	3 VTX-SS	3 VTX-B	420	350
6	1/4	1/4	1/8-27	7/16-20	4	5	18	16	11	18	4VMTXS	4 VTX-SS	4 VTX-B	420	350
6	1/4	1/4	1/4-18	7/16-20	4	7	21	22	14	30	4-4VMTXS	4-4 VTX-SS	4-4 VTX-B	420	350
8	5/16	1/8	1/8-27	1/2-20	6	5	20	16	13	22	5VMTXS	5 VTX-SS	5 VTX-B	420	350
8	5/16	1/4	1/4-18	1/2-20	6	7	21	22	14	31	5-4VMTXS	5-4 VTX-SS	5-4 VTX-B	420	350
10	3/8	1/4	1/4-16	9/16-18	8	7	21	22	14	27	6VMTXS	6 VTX-SS	6 VTX-B	420	350
10	3/8	1/8	1/8-27	9/16-18	8	5	21	17	14	23	6-2 VTX-S	6-2 VTX-SS	6-2 VTX-B	420	350
10	3/8	3/8	3/8-18	9/16-18	8	10	22	24	19	52	6-6 VTX-S	6-6 VTX-SS	6-6 VTX-B	420	350
10	3/8	1/2	1/2-14	9/16-18	8	14	22	30	22	74	6-8VMTXS	6-8 VTX-SS	6-8 VTX-B	420	350
12	1/2	1/4	1/4-16	3/4-16	10	7	25	24	19	62	8-4 VTX-S	8-4 VTX-SS	8-4 VTX-B	420	350
12	1/2	3/8	3/8-18	3/4-16	10	10	25	24	19	61	8 VTX-S	8 VTX-SS	8 VTX-B	420	350
12	1/2	1/2	1/2-14	3/4-18	10	14	25	30	22	92	8-8VMTXS	8-8 VTX-SS	8-8 VTX-B	420	350
12	1/2	3/4	3/4-14	3/4-18	10	18	26	31	27	144	8-12 VTX-S	8-12 VTX-SS	8-12 VTX-B	280	280
14, 15, 16	5/8	1/2	1/2-14	7/8-14	12	14	28	30	22	92	10VMTXS	10 VTX-SS	10 VTX-B	350	350
14, 15, 16	5/8	3/8	3/8-18	7/8-14	12	10	28	25	22	94	10-6 VTX-S	10-6 VTX-SS	10-6 VTX-B	350	350
14, 15, 16	5/8	3/4	3/4-14	7/8-14	12	18	30	31	27	156	10-12VMTXS	10-12 VTX-SS		280	280
18, 20	3/4	3/4	3/4-14	1 1/16-12	16	18	33	31	27	148	12VMTXS	12 VTX-SS	12 VTX-B	280	280
18, 20	3/4	1/2	1/2-14	1 1/16-12	16	14	36	31	27	144	12-8VMTXS	12-8 VTX-SS	12-8 VTX-B	350	350
18, 20	3/4	1-11	1-11 1/2	1 1/16-12	16	24	36	38	33	169	12-16 VTX-S	12-16 VTX-SS	12-16 VTX-B	210	210
22	7/8	3/4	3/4-14	1 3/16-12	18	18	35	32	33	197	14 VTX-S	14 VTX-B		280	280
25	1	1-11	1-11 1/2	1 5/16-12	22	24	37	38	33	239	16VMTXS	16 VTX-SS	16 VTX-B	210	210
25	1	3/4	3/4-14	1 5/16-12	22	18	37	33	33	213	16-12 VTX-S	16-12 VTX-SS	16-12 VTX-B	280	280
28, 30, 32	1 1/4	1 1/4	1 1/4-11 1/2	1 5/8-12	28	32	40	42	41	385	20VMTXS	20 VTX-SS	20 VTX-B	170	170
35, 38	1 1/2	1 1/2	1 1/2-11 1/2	1 7/8-12	33	38	45	45	48	495	24 VTX-S	24 VTX-SS	24 VTX-B	170	140

Die angegebenen Artikel entsprechen unserem Standard-Lieferprogramm.
Zöllige und metrische Versionen können sich in der Schlüsselweite unterscheiden.

$$\frac{\text{PN (bar)}}{10} = \text{PN (MPa)}$$

Die angegebenen Nenndrücke PN beziehen sich auf die Stahl- und Edelstahlversion der Verschraubung.
Für Messingverschraubungen sind diese Drücke um 35% zu reduzieren.

V3MX 45° Einschraubstutzen

Triple-Lok® 37° Bördelanschluss / Zöll. (BSPT) Einschraubzapfen – kegelig (ISO 7)

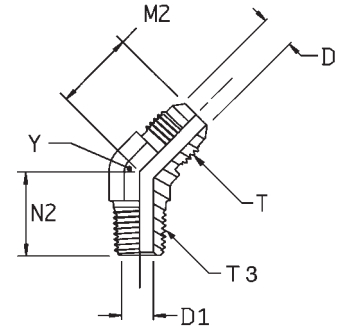

Rohr A.D.		Gewinde BSPT T3	Gewinde UN/UNF-2A T	D mm	D1 mm	M2 mm	N2 mm	Y mm	Gewicht (Stahl) g/1 St.	Triple-Lok® Stahl	PN (bar)
mm	Zoll										
6	1/4	1/8-27	7/16-20	4	5	18	16	11	18	4V3MXS	315
6	1/4	1/4-18	7/16-20	4	7	21	22	14	30	4-4V3MXS	315
8	5/16	1/8-27	1/2-20	6	5	20	16	13	22	5V3MXS	315
8	5/16	1/4-18	1/2-20	6	7	21	22	14	31	5-4V3MXS	315
10	3/8	1/4-16	9/16-18	8	7	21	22	14	27	6V3MXS	315
10	3/8	3/8-18	9/16-18	8	10	22	24	19	52	6-6V3MXS	315
10	3/8	1/2-14	9/16-18	8	14	22	30	22	74	6-8V3MXS	315
12	1/2	3/8-18	3/4-16	10	10	25	24	19	61	8V3MXS	315
12	1/2	1/2-14	3/4-16	10	14	25	30	22	92	8-8V3MXS	315
14, 15, 16	5/8	1/2-14	7/8-14	12	14	28	30	22	92	10V3MXS	315
18, 20	3/4	3/4-14	1 1/16-12	16	18	33	31	27	148	12V3MXS	160
25	1	1-11	1 5/16-12	22	24	37	38	33	239	16V3MXS	160
28, 30, 32	1 1/4	1 1/4-11	1 5/8-12	28	32	40	42	41	385	20V3MXS	160
35, 38	1 1/2	1 1/2-11	1 7/8-12	33	38	45	45	48	495	24V3MXS	160

Die angegebenen Artikel entsprechen unserem Standard-Lieferprogramm.
Zöllige und metrische Versionen können sich in der Schlüsselweite unterscheiden.

$$\frac{\text{PN (bar)}}{10} = \text{PN (MPa)}$$

S87OMX T-Einschraubstutzen

Triple-Lok® 37° Bördelanschluss / Metr. Einschraubzapfen – O-Ring (ISO 6149)

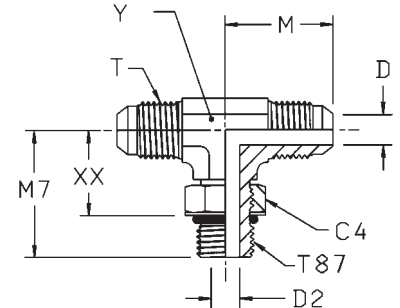

Rohr A.D.	Gewinde Metrisch T87	Gewinde UN/UNF-2A T	C4 mm	D mm	D2 mm	M mm	M7 mm	XX mm	Y mm	Gewicht (Stahl) g/1 St.	Triple-Lok® Stahl	PN (bar)
6	M10 × 1,0	7/16-20	14	4	5	23	27	16	11	27	4M10S87OMXS	420
8	M12 × 1,5	1/2-20	17	6	6	24	31	19	13	42	5M12S87OMXS	420
10	M14 × 1,5	9/16-18	19	8	8	27	34	21	14	53	6M14S87OMXS	420
12	M16 × 1,5	3/4-16	22	10	9	32	38	24	19	113	8M16S87OMXS	350
12	M18 × 1,5	3/4-16	24	10	11	32	38	24	19	114	8M18S87OMXS	350
14, 15,16	M18 × 1,5	7/8-14	24	12	11	37	42	28	22	174	10M18S87OMXS	350
14, 15,16	M22 × 1,5	7/8-14	27	12	14	37	43	29	22	175	10M22S87OMXS	350
18, 20	M22 × 1,5	1 1/16-12	27	16	14	42	45	32	27	295	12M22S87OMXS	350
18, 20	M27 × 2,0	1 1/16-12	32	16	18	42	48	33	27	304	12M27S87OMXS	350
25	M27 × 2,0	1 5/16-12	32	22	18	46	53	36	33	491	16M27S87OMXS	280
25	M33 × 2,0	1 5/16-12	41	22	23	46	53	38	33	530	16M33S87OMXS	280

Triple-Lok® Verschraubungen werden standardmäßig mit NBR Dichtung geliefert. Für alternative Dichtungswerkstoffe siehe Seite K93
Die angegebenen Artikel entsprechen unsererem Standard-Lieferprogramm.
Zöllige und metrische Versionen können sich in der Schlüsselweite unterscheiden.

$$\frac{\text{PN (bar)}}{10} = \text{PN (MPa)}$$

K

S50MX T-Einschraubstutzen

Triple-Lok® 37° Bördelanschluss / UN/UNF Einschraubzapfen – O-Ring (ISO 11926)
SAE 070429 MS51529

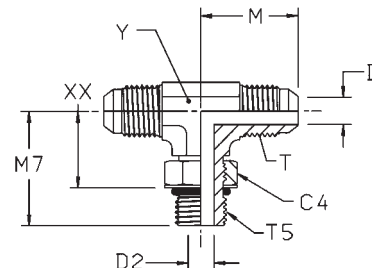

Rohr A.D.		Gewinde UN/UNF-2A T5	Gewinde UN/UNF-2A T	C4	D	D2	M	M7	XX	Y	Gewicht (Stahl) g/1 St.	Triple-Lok® Stahl	Triple-Lok® Edelstahl	PN (bar)	
mm	Zoll			mm	mm	mm	mm	mm	mm	mm				S	SS
6	1/4	7/16-20	7/16-20	14	4	5	23	26	16	11	46	4S50MXS	4 S50X-SS	420	350
8	5/16	1/2-20	1/2-20	16	6	6	25	29	18	14	66	5 S50X-S	5 S50X-SS	420	350
10	3/8	9/16-18	9/16-18	17	8	8	27	32	21	14	76	6S50MXS	6 S50X-SS	420	350
12	1/2	3/4-16	3/4-16	22	10	10	32	37	24	19	150	8S50MXS	8 S50X-SS	420	350
14, 15, 16	5/8	7/8-14	7/8-14	27	12	13	37	43	29	22	224	10S50MXS	10 S50X-SS	350	350
18, 20	3/4	1 1/16-12	1 1/16-12	32	16	16	42	49	33	27	367	12 S50X-S	12 S50X-SS	350	350
25	1	1 5/16-12	1 5/16-12	38	22	22	46	52	36	33	506	16 S50X-S	16 S50X-SS	280	280
28, 30, 32	1 1/4	1 5/8-12	1 5/8-12	48	28	28	52	57	41	42	1053	20 S50X-S	20 S50X-SS	280	280
35, 38	1 1/2	1 7/8-12	1 7/8-12	55	34	34	59	61	44	48	1296	24 S50X-S		210	—
	2	2 1/2-12	2 1/2-12	70	45	45	78	73	57	66	2000	32 S50X-S		140	—

Triple-Lok® Verschraubungen werden standardmäßig mit NBR Dichtung geliefert. Für alternative Dichtungswerkstoffe siehe Seite K93
Die angegebenen Artikel entsprechen unserem Standard-Lieferprogramm.
Zöllige und metrische Versionen können sich in der Schlüsselweite unterscheiden.

$$\frac{\text{PN (bar)}}{10} = \text{PN (MPa)}$$

Die angegebenen Nenndrücke PN beziehen sich auf die Stahl- und Edelstahlversion der Verschraubung.

S4OMX T-Einschraubstutzen

Triple-Lok® 37° Bördelanschluss /
Zöll. Einschraubzapfen, einstellbar – O-Ring + Kammerring (ISO 1179)

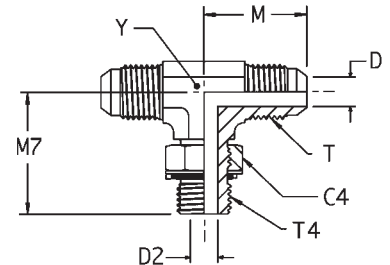

Rohr A.D.		Gewinde BSPP T4	Gewinde UN/UNF-2A T	C4 mm	D mm	D2 mm	M mm	M7 mm	Y mm	Gewicht (Stahl) g/1 St.	Triple-Lok® Stahl	Triple-Lok® Edelstahl	PN (bar)	
mm	Zoll													
6	1/4	1/8-28	7/16-20	14	4	4	23	27	11	47	4S4OMXS	4S4OMXSS	250	250
10	3/8	1/4-19	9/16-18	19	8	8	27	32	14	78	6S4OMXS	6S4OMXSS	250	200
12	1/2	3/8-19	3/4-16	22	10	10	32	37	19	154	8S4OMXS	8S4OMXSS	250	200
12	1/2	1/2-14	3/4-16	27	10	12	34	44	22	186	8-8-8S4OMXS	8-8-8S4OMXSS	250	200
14, 15, 16	5/8	1/2-14	7/8-14	27	12	12	37	43	22	231	10S4OMXS	10S4OMXSS	250	200
18, 20	3/4	3/4-14	1 1/16-12	36	16	16	42	50	27	379	12S4OMXS	12S4OMXSS	250	200
25	1	1-11	1 5/16-12	41	22	22	46	52	33	569	16S4OMXS	16S4OMXSS	250	200
28, 30, 32	1 1/4	1 1/4-11	1 5/8-12	50	28	28	52	57	41	1075	20S4OMXS	20S4OMXSS	210	160

Triple-Lok® Verschraubungen werden standardmäßig mit NBR Dichtung geliefert. Für alternative Dichtungswerkstoffe siehe Seite K93

Die angegebenen Artikel entsprechen unserem Standard-Lieferprogramm.

Zöllige und metrische Versionen können sich in der Schlüsselweite unterscheiden.

$$\frac{\text{PN (bar)}}{10} = \text{PN (MPa)}$$

Die angegebenen Nenndrücke PN beziehen sich auf die Stahl- und Edelstahlversion der Verschraubung.

K

S8OMX T-Einschraubstutzen

Triple-Lok® 37° Bördelanschluss / Metr. Einschraubzapfen – O-Ring + Kammerring

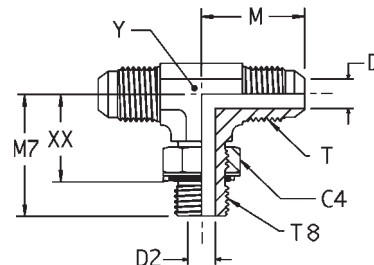

Rohr A.D.	Gewinde	Gewinde	C4	D	D2	M	M7	XX	Y	Gewicht	Triple-Lok®	PN	
mm	Zoll	Metrisch T8	UN/UNF-2A T	mm	mm	mm	mm	mm	mm	(Stahl) g/1 St.	Stahl	(bar)	
6	1/4	M10 × 1,0	7/16-20	13	4	5	23	27	17	11	27	4M10S8OMXS	250
8	5/16	M12 × 1,5	1/2-20	17	6	6	24	31	20	13	42	5M12S8OMXS	250
10	3/8	M14 × 1,5	9/16-18	17	8	8	27	34	22	14	53	6M14S8OMXS	250
12	1/2	M16 × 1,5	3/4-16	19	10	9	32	38	24	19	95	8M16S8OMXS	250
12	1/2	M18 × 1,5	3/4-16	22	10	11	32	38	26	19	114	8M18S8OMXS	250
14, 15,16	5/8	M22 × 1,5	7/8-14	27	12	14	37	43	30	22	175	10M22S8OMXS	250
18, 20	3/4	M27 × 2,0	1 1/16-12	32	16	18	42	48	35	27	304	12M27S8OMXS	175
25	1	M33 × 2,0	1 5/16-12	38	22	23	46	53	38	33	491	16M33S8OMXS	140

Triple-Lok® Verschraubungen werden standardmäßig mit NBR Dichtung geliefert. Für alternative Dichtungswerkstoffe siehe Seite K93

Die angegebenen Artikel entsprechen unserem Standard-Lieferprogramm.

Zöllige und metrische Versionen können sich in der Schlüsselweite unterscheiden.

$$\frac{\text{PN (bar)}}{10} = \text{PN (MPa)}$$

SMTX T-Einschraubstutzen

Triple-Lok® 37° Bördelanschluss / NPTF* Einschraubzapfen (SAE J476)

SAE 070425 MS51512

*Edelstahl = NPT Gewinde

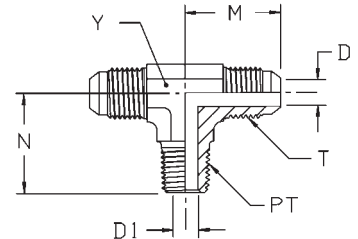

Rohr A.D. mm	Zoll	Gewinde NPT/NPTF PT	Gewinde UN/UNF-2A T	D mm	D1 mm	M mm	N mm	Y mm	Gewicht (Stahl) g/1 St.	Triple-Lok® Stahl	Triple-Lok® Edelstahl	Triple-Lok® Messing	PN (bar)	
													S	SS
6	3/16	1/8-27	3/8-24	3	5	21	18	11	25	3 STX-S	3 STX-SS	3 STX-B	420	350
	1/4	1/8-27	7/16-20	4	5	23	20	11	31	4 STX-S	4 STX-SS	4 STX-B	420	350
	1/4	1/4-18	7/16-20	4	7	27	28	14	49	4-4-4 STX-S	4-4-4 STX-SS	4-4-4 STX-B	420	350
	5/16	1/8-27	1/2-20	6	5	24	20	14	37	5 STX-S	5 STX-SS	5 STX-B	420	350
10	3/8	1/4-16	9/16-18	8	7	27	28	14	57	6SMTXS	6 STX-SS	6 STX-B	420	350
		3/8-18	9/16-18	8	10	29	31	19	77	6-6-6 STX-S	6-6-6 STX-SS	6-6-6 STX-B	420	350
12	1/2	3/8-18	3/4-16	10	10	32	31	19	113	8 STX-S	8 STX-SS	8 STX-B	420	350
12	1/2	1/2-14	3/4-16	10	14	34	37	22	164	8-8-8 STX-S	8-8-8 STX-SS	8-8-8 STX-B	420	350
14, 15, 16	5/8	1/2-14	7/8-14	12	14	37	37	22	173	10 STX-S	10 STX-SS	10 STX-B	350	350
										12 STX-S	12 STX-SS	12 STX-B	280	280
18, 20	3/4	3/4-14	1 1/16-12	16	18	42	40	27	272	12 STX-S	12 STX-SS	12 STX-B	280	280
22	7/8	3/4-14	1 3/16-12	18	18	46	43	33	323	14 STX-S			280	—
25	1	1-11 1/2	1 5/16-12	21	24	46	50	33	413	16 STX-S	16 STX-SS	16 STX-B	210	210
28, 30, 32	1 1/4	1 1/4-11 1/2	1 5/8-12	27	32	52	61	41	681	20 STX-S	20 STX-SS	20 STX-B	170	170
										24 STX-S	24 STX-SS	24 STX-B	170	170

Die angegebenen Artikel entsprechen unserem Standard-Lieferprogramm.
Zöllige und metrische Versionen können sich in der Schlüsselweite unterscheiden.

$$\frac{\text{PN (bar)}}{10} = \text{PN (MPa)}$$

Die angegebenen Nenndrücke PN beziehen sich auf die Stahl- und Edelstahlversion der Verschraubung.
Für Messingverschraubungen sind diese Drücke um 35% zu reduzieren.



S3MX T-Einschraubstutzen

Triple-Lok® 37° Bördelanschluss / Zöll. (BSPT) Einschraubzapfen – kegelig (ISO 7)

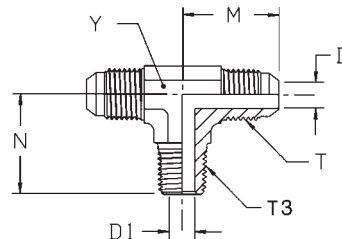

Rohr A.D.		Gewinde BSPT T3	Gewinde UN/UNF-2A T	D mm	D1 mm	M mm	N mm	Y mm	Gewicht (Stahl) g/1 St.	Triple-Lok® Stahl	Triple-Lok® Edelstahl	PN (bar)	
mm	Zoll											S	SS
6	1/4	1/8-28	7/16-20	4	5	23	20	11	30	4S3MXS	4S3MXSS	315	315
10	3/8	1/4-19	9/16-18	8	7	27	28	14	55	6S3MXS	6S3MXSS	315	315
12	1/2	3/8-19	3/4-16	10	10	32	31	19	111	8S3MXS	8S3MXSS	315	315
14, 15, 16	5/8	1/2-14	7/8-14	12	14	37	37	22	169	10S3MXS	10S3MXSS	315	315
18, 20	3/4	3/4-14	1 1/16-12	16	18	42	40	27	267	12S3MXS	12S3MXSS	160	160
25	1	1-11	1 5/16-12	22	24	46	50	33	407	16S3MXS	16S3MXSS	160	160

Die angegebenen Artikel entsprechen unserem Standard-Lieferprogramm.
Zöllige und metrische Versionen können sich in der Schlüsselweite unterscheiden.

$$\frac{\text{PN (bar)}}{10} = \text{PN (MPa)}$$

Die angegebenen Nenndrücke PN beziehen sich auf die Stahl- und Edelstahlversion der Verschraubung.

R87OMX L-Einschraubstutzen

Triple-Lok® 37° Bördelanschluss / Metr. Einschraubzapfen – O-Ring (ISO 6149)

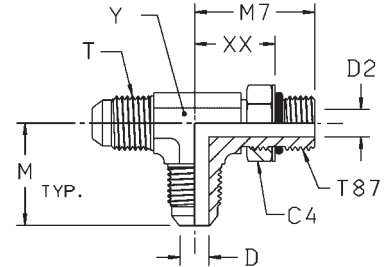

Rohr A.D.	Gewinde	Gewinde	C4	D	D2	M	M7	XX	Y	Gewicht	Triple-Lok®	PN	
mm	Zoll	Metrisch T87	UN/UNF-2A T	mm	mm	mm	mm	mm	mm	(Stahl) g/1 St.	Stahl	(bar)	
6	1/4	M10 × 1,0	7/16-20	14	4	5	23	27	16	11	27	4M10R87OMXS	420
10	3/8	M14 × 1,5	9/16-18	19	8	8	27	34	21	14	53	6M14R87OMXS	420
10	3/8	M18 × 1,5	9/16-18	24	8	11	29	38	24	19	90	6M18R87OMXS	350
12	1/2	M16 × 1,5	3/4-16	22	10	9	32	38	24	19	113	8M16R87OMXS	350
12	1/2	M18 × 1,5	3/4-16	24	10	11	32	37	24	19	114	8M18R87OMXS	350
14, 15,16	5/8	M18 × 1,5	7/8-14	24	12	11	37	42	29	22	174	10M18R87OMXS	350
14, 15,16	5/8	M22 × 1,5	7/8-14	27	12	14	37	43	29	22	175	10M22R87OMXS	350
18, 20	3/4	M22 × 1,5	1 1/16-12	27	16	14	42	45	32	27	295	12M22R87OMXS	350
18, 20	3/4	M27 × 2,0	1 1/16-12	32	16	18	42	51	33	27	315	12M27R87OMXS	350
25	1	M33 × 2,0	1 5/16-12	41	22	23	46	53	40	33	495	16M33R87OMXS	280

Triple-Lok® Verschraubungen werden standardmäßig mit NBR Dichtung geliefert. Für alternative Dichtungswerkstoffe siehe Seite K93
Die angegebenen Artikel entsprechen unserem Standard-Lieferprogramm.
Zöllige und metrische Versionen können sich in der Schlüsselweite unterscheiden.

$\frac{\text{PN (bar)}}{10} = \text{PN (MPa)}$

K

R5OMX L-Einschraubstutzen

Triple-Lok® 37° Bördelanschluss / UN/UNF Einschraubzapfen – O-Ring (ISO 11926)
SAE 070428 MS51530

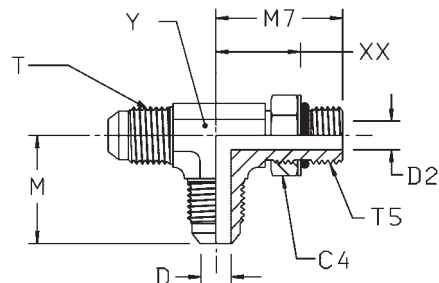

Rohr A.D.		Gewinde UN/UNF-2A T5	Gewinde UN/UNF-2A T	C4 mm	D mm	D2 mm	M mm	M7 mm	XX mm	Y mm	Gewicht (Stahl) g/1 St.	Triple-Lok® Stahl	Triple-Lok® Edelstahl	PN (bar)	
mm	Zoll													S	SS
6	1/4	7/16-20	7/16-20	14	4	4	23	26	16	11	46	4 R50X-S	4 R50X-SS	420	350
8	5/16	1/2-20	1/2-20	16	6	6	25	29	18	14	66	5 R50X-S	5 R50X-SS	420	350
10	3/8	9/16-18	9/16-18	17	8	8	27	32	21	14	76	6R50MXS	6 R50X-SS	420	350
12	1/2	3/4-16	3/4-16	22	10	10	32	37	24	19	151	8R50MXS	8 R50X-SS	420	350
14, 15, 16	5/8	7/8-14	7/8-14	25	12	12	37	43	29	22	226	10 R50X-S	10 R50X-SS	350	350
18, 20	3/4	1 1/16-12	1 1/16-12	32	16	16	42	49	33	27	372	12 R50X-S	12 R50X-SS	350	350
25	1	1 5/16-12	1 5/16-12	38	22	22	46	52	36	33	557	16 R50X-S	16 R50X-SS	280	280
28, 30, 32	1 1/4	1 5/8-12	1 5/8-12	48	28	28	52	57	41	41	1053	20 R50X-S	20 R50X-SS	280	280
35, 38	1 1/2	1 7/8-12	1 7/8-12	54	33	33	59	61	44	48	1296	24 R50X-S	24 R50X-SS	210	210
	2	2 1/2-12	2 1/2-12	70	45	45	78	73	57	66	2000	32 R50X-S	32 R50X-SS	140	140

Triple-Lok® Verschraubungen werden standardmäßig mit NBR Dichtung geliefert. Für alternative Dichtungswerkstoffe siehe Seite K93
Die angegebenen Artikel entsprechen unserem Standard-Lieferprogramm.
Zöllige und metrische Versionen können sich in der Schlüsselweite unterscheiden.

$$\frac{\text{PN (bar)}}{10} = \text{PN (MPa)}$$

Die angegebenen Nenndrücke PN beziehen sich auf die Stahl- und Edelstahlversion der Verschraubung.

R4OMX L-Einschraubstutzen

Triple-Lok® 37° Bördelanschluss /
Zöll. Einschraubzapfen, einstellbar – O-Ring + Kammerring (ISO 1179)

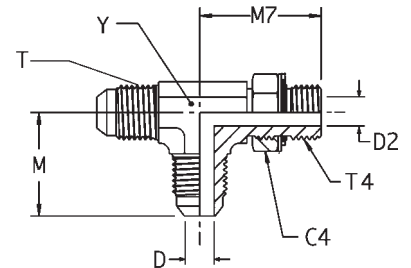

Rohr A.D.		Gewinde BSPP T4	Gewinde UN/UNF-2A T	C4 mm	D mm	D2 mm	M mm	M7 mm	Y mm	Gewicht (Stahl) g/1 St.	Triple-Lok® Stahl	Triple-Lok® Edelstahl	PN (bar)	
mm	Zoll												S	SS
6	1/4	1/8-28	7/16-20	14	4	4	23	27	11	47	4R4OMXS	4R4OMXSS	250	200
10	3/8	1/4-19	9/16-18	19	8	8	27	32	14	78	6R4OMXS	6R4OMXSS	250	200
12	1/2	3/8-19	3/4-16	22	10	10	32	37	19	154	8R4OMXS	8R4OMXSS	250	200
14, 15, 16	5/8	1/2-14	7/8-14	27	12	12	37	43	22	231	10R4OMXS	10R4OMXSS	250	200
18, 20	3/4	3/4-14	1 1/16-12	36	16	16	42	50	27	379	12R4OMXS	12R4OMXSS	250	200
25	1	1-11	1 5/16-12	41	22	22	46	52	33	569	16R4OMXS	16R4OMXSS	250	200
28, 30, 32	1 1/4	1 1/4-11	1 5/8-12	50	28	28	52	57	41	1075	20R4OMXS	20R4OMXSS	210	160

Triple-Lok® Verschraubungen werden standardmäßig mit NBR Dichtung geliefert. Für alternative Dichtungswerkstoffe siehe Seite K93
Die angegebenen Artikel entsprechen unserem Standard-Lieferprogramm.
Zöllige und metrische Versionen können sich in der Schlüsselweite unterscheiden.

$$\frac{\text{PN (bar)}}{10} = \text{PN (MPa)}$$

Die angegebenen Nenndrücke PN beziehen sich auf die Stahl- und Edelstahlversion der Verschraubung.

K

R8OMX L-Einschraubstutzen

Triple-Lok® 37° Bördelanschluss / Metr. Einschraubzapfen – O-Ring + Kammerring

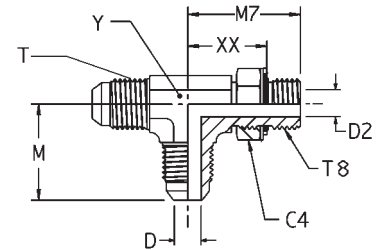

Rohr A.D. mm	Zoll	Gewinde Metrisch T87	Gewinde UN/UNF-2A T	C4 mm	D mm	D2 mm	M mm	M7 mm	XX mm	Y mm	Gewicht (Stahl) g/1 St.	Triple-Lok® Stahl	PN (bar)
6	1/4	M10 × 1,0	7/16-20	13	4	5	23	27	17	11	27	4M10R8OMXS	250
8	5/16	M12 × 1,5	1/2-20	17	6	6	24	31	20	13	42	5M12R8OMXS	250
10	3/8	M14 × 1,5	9/16-18	17	8	8	27	34	22	14	53	6M14R8OMXS	250
12	1/2	M16 × 1,5	3/4-16	19	10	9	32	38	24	19	95	8M16R8OMXS	250
12	1/2	M18 × 1,5	3/4-16	22	10	10	32	37	26	19	114	8M18R8OMXS	250
14, 15,16	5/8	M22 × 1,5	7/8-14	27	12	14	37	43	30	22	175	10M22R8OMXS	250
18, 20	3/4	M27 × 2,0	1 1/16-12	32	16	18	42	51	35	27	304	12M27R8OMXS	175
25	1	M33 × 2,0	1 5/16-12	38	22	23	46	53	38	33	491	16M33R8OMXS	140

Triple-Lok® Verschraubungen werden standardmäßig mit NBR Dichtung geliefert. Für alternative Dichtungswerkstoffe siehe Seite K93
Die angegebenen Artikel entsprechen unserem Standard-Lieferprogramm.
Zöllige und metrische Versionen können sich in der Schlüsselweite unterscheiden.

$$\frac{\text{PN (bar)}}{10} = \text{PN (MPa)}$$

RMTX L-Einschraubstutzen

Triple-Lok® 37° Bördelanschluss / NPTF* Einschraubzapfen (SAE J476)

SAE 070424 MS51511

*Edelstahl = NPT Gewinde

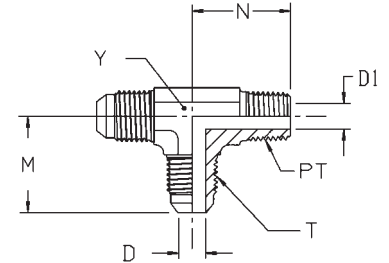

Rohr A.D. mm	Zoll	Gewinde NPT/NPTF PT	Gewinde UN/UNF-2A T	D mm	D1 mm	M mm	N mm	Y mm	Gewicht (Stahl) g/1 St.	Triple-Lok® Stahl	Triple-Lok® Edelstahl	Triple-Lok® Messing	PN (bar)	
													S	SS
6	3/16	1/8-27	3/8-24	3	5	21	18	11	25	3 RTX-S	3 RTX-SS		420	350
	1/4	1/8-27	7/16-20	4	5	23	20	11	31	4 RTX-S	4 RTX-SS	4 RTX-B	420	350
	1/4	1/4-18	7/16-20	4	7	27	28	14	49	4-4-4 RTX-S	4-4-4 RTX-SS	4-4-4 RTX-B	420	350
	5/16	1/8-27	1/2-20	6	5	25	21	14	37	5 RTX-S	5 RTX-SS	5 RTX-B	420	350
10	3/8	1/4-16	9/16-18	8	7	27	28	14	57	6 RTX-S	6 RTX-SS	6 RTX-B	420	350
		3/8-18	9/16-18	8	10	29	31	19	77	6-6-6 RTX-S	6-6-6 RTX-SS	6-6-6 RTX-B	420	350
12	1/2	3/8-18	3/4-16	10	10	32	31	19	109	8 RTX-S	8 RTX-SS	8 RTX-B	420	350
		1/2-14	3/4-16	10	14	34	37	22	163	8-8-8RMTXS	8-8-8 RTX-SS	8-8-8 RTX-B	420	350
14, 15, 16	5/8	1/2-14	7/8-14	12	14	37	37	22	172	10 RTX-S	10 RTX-SS	10 RTX-B	350	350
										12 RTX-S	12 RTX-SS	12 RTX-B	280	280
22	7/8	3/4-14	1 1/16-12	18	18	46	43	33	323	14 RTX-S			280	—
										16 RTX-S	16 RTX-SS	16 RTX-B	210	210
28, 30, 32	1 1/4	1 1/4-11 1/2	1 5/8-12	27	32	52	61	41	681	20 RTX-S	20 RTX-SS	20 RTX-B	170	170
										24 RTX-S	24 RTX-SS		170	140
35, 38	1 1/2	1 1/2-11 1/2	1 7/8-12	33	38	59	67	48	905					

Die angegebenen Artikel entsprechen unserem Standard-Lieferprogramm.
Zöllige und metrische Versionen können sich in der Schlüsselweite unterscheiden.

$$\frac{\text{PN (bar)}}{10} = \text{PN (MPa)}$$

Die angegebenen Nenndrücke PN beziehen sich auf die Stahl- und Edelstahlversion der Verschraubung.
Für Messingverschraubungen sind diese Drücke um 35% zu reduzieren.

K

R3MX L-Einschraubstutzen

Triple-Lok® 37° Bördelanschluss / Zöll. (BSPT) Einschraubzapfen – kegelig (ISO 7)

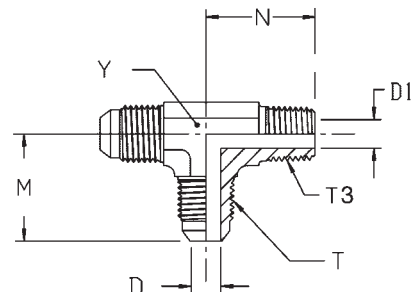

Rohr A.D. mm	Zoll	Gewinde BSPT T3	Gewinde UN/UNF-2A T	D mm	D1 mm	M mm	N mm	Y mm	Gewicht (Stahl) g/1 St.	Triple-Lok® Stahl	Triple-Lok® Edelstahl	PN (bar)	
												S	SS
6	1/4	1/8-28	7/16-20	4	5	23	20	11	30	4R3MXS	4R3MXSS	315	315
8	5/16	1/8-28	1/2-20	6	5	24	20	13	36	5R3MXS	5R3MXSS	315	315
10	3/8	1/4-19	9/16-18	8	7	27	28	14	55	6R3MXS	6R3MXSS	315	315
12	1/2	3/8-19	3/4-16	10	10	32	31	19	107	8R3MXS	8R3MXSS	315	315
14, 15, 16	5/8	1/2-14	7/8-14	12	14	37	37	22	170	10R3MXS	10R3MXSS	315	315

Die angegebenen Artikel entsprechen unsererem Standard-Lieferprogramm.
Zöllige und metrische Versionen können sich in der Schlüsselweite unterscheiden.

$$\frac{\text{PN (bar)}}{10} = \text{PN (MPa)}$$

Die angegebenen Nenndrücke PN beziehen sich auf die Stahl- und Edelstahlversion der Verschraubung.

G4MX Gerader Aufschraubstutzen

Triple-Lok® 37° Bördelanschluss / Zöll. Innengewinde (ISO 1179-1)

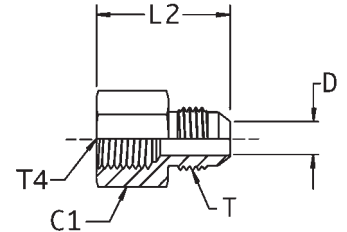

Rohr A.D. mm	Zoll	Gewinde BSPP T4	Gewinde UN/UNF-2A T	C1 mm	D mm	L2 mm	Gewicht (Stahl) g/1 St.	Triple-Lok® Stahl	Triple-Lok® Edelstahl	PN (bar)	
										S	SS
6	1/4	1/8-28	7/16-20	16	4	30	15	4G4MXS	4G4MXSS	315	315
6	1/4	1/4-19	7/16-20	19	4	35	42	4-4G4MXS	4-4G4MXSS	400	350
8	5/16	1/8-28	1/2-20	16	6	30	22	5G4MXS	5G4MXSS	315	315
8	5/16	1/4-19	1/2-20	19	6	35	40	5-4G4MXS	5-4G4MXSS	400	350
10	3/8	1/4-19	9/16-18	19	8	36	40	6G4MXS	6G4MXSS	400	350
10	3/8	3/8-19	9/16-18	22	8	37	50	6-6G4MXS	6-6G4MXSS	350	350
12	1/2	3/8-19	3/4-16	22	10	40	64	8G4MXS	8G4MXSS	350	350
12	1/2	1/2-14	3/4-16	30	10	46	116	8-8G4MXS	8-8G4MXSS	400	350
14, 15, 16	5/8	1/2-14	7/8-14	30	12	48	121	10G4MXS	10G4MXSS	350	350
18, 20	3/4	3/4-14	1 1/16-12	36	16	52	188	12G4MXS	12G4MXSS	315	315
25	1	1 1/4	1 5/16-12	46	22	60	340	16G4MXS	16G4MXSS	280	280
28, 30, 32	1 1/4	1 1/4-11	1 5/8-12	50	28	63	438	20G4MXS	20G4MXSS	210	210
35, 38	1 1/2	1 1/2-11	1 7/8-12	55	33	67	526	24G4MXS	24G4MXSS	140	140

Die angegebenen Artikel entsprechen unserem Standard-Lieferprogramm.
Zöllige und metrische Versionen können sich in der Schlüsselweite unterscheiden.

$$\frac{\text{PN (bar)}}{10} = \text{PN (MPa)}$$

Die angegebenen Nenndrücke PN beziehen sich auf die Stahl- und Edelstahlversion der Verschraubung.



GMTX Gerader Aufschraubstutzen

Triple-Lok® 37° Bördelanschluss / NPTF* Innengewinde (SAE J476)

SAE 070103 MS51503

*Edelstahl = NPT Gewinde

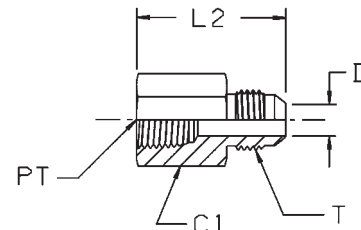

Rohr A.D. mm	Zoll	Gewinde NPT/NPTF PT	Gewinde UN/UNF-2A T	C1 mm	D mm	L2 mm	Gewicht (Stahl) g/1 St.	Triple-Lok®		PN (bar)	
								Stahl	Edelstahl	S	SS
6	1/4	1/8-27	7/16-20	14	4	30	42	4 GTX-S	4GMTXSS	420	350
6	1/4	1/4-18	7/16-20	19	4	36	40	4-4GMTXS	4-4GMTXSS	420	350
6	1/4	3/8-18	7/16-20	22	5	37	40	4-6 GTX-S	4-6GMTXSS	420	350
6	1/4	1/2-14	7/16-20	29	5	37	42	4-8 GTX-S	4-8GMTXSS	350	350
8	5/16	1/8-27	1/2-20	14	6	30	40	5 GTX-S	5GMTXSS	420	350
8	5/16	1/4-18	1/2-20	19	6	35	42	5-4 GTX-S	5-4GMTXSS	420	350
10	3/8	1/4-18	9/16-18	19	8	36	40	6GMTXS	6GMTXSS	420	350
10	3/8	3/8-18	9/16-18	22	8	37	62	6-6 GTX-S	6-6GMTXSS	420	350
10	3/8	1/2-14	9/16-18	29	8	45	90	6-8 GTX-S	6-8GMTXSS	350	350
12	1/2	3/8-18	3/4-16	22	10	40	45	8 GTX-S	8GMTXSS	420	350
12	1/2	1/4-18	3/4-16	21	10	36	80	8-4 GTX-S	8-4GMTXSS	420	350
12	1/2	1/2-14	3/4-16	29	10	46	116	8-8 GTX-S	8-8GMTXSS	350	350
12	1/2	3/4-14	3/4-16	35	10	48	150	8-12 GTX-S	8-12GMTXSS	280	280
14, 15,16	5/8	1/2-14	7/8-14	29	12	48	121	10 GTX-S	10GMTXSS	350	350
14, 15,16	5/8	3/4-14	7/8-14	35	13	51	182	10-12 GTX-S	10-12GMTXSS	280	280
18, 20	3/4	3/4-14	1 1/16-12	35	16	52	188	12 GTX-S	12GMTXSS	280	280
18, 20	3/4	1/2-14	1 1/16-12	29	16	49	133	12-8 GTX-S	12-8GMTXSS	350	350
22	7/8	3/4-14	1 3/16-12	35	18	52	201	14 GTX-S	14GMTXSS	210	210
25	1	1-11 1/2	1 5/16-12	41	22	59	280	16 GTX-S	16GMTXSS	210	210
28, 30, 32	1 1/4	1 1/4-11 1/2	1 5/8-12	51	27	63	408	20 GTX-S	20GMTXSS	170	170
35, 38	1 1/2	1 1/2-11 1/2	1 7/8-12	60	33	67	370	24 GTX-S	24GMTXSS	140	140
	2	2-11 1/2	2 1/2-12	73	44	75	1262	32 GTX-S		140	—

Die angegebenen Artikel entsprechen unserem Standard-Lieferprogramm.
Zöllige und metrische Versionen können sich in der Schlüsselweite unterscheiden.

$$\frac{\text{PN (bar)}}{10} = \text{PN (MPa)}$$

Die angegebenen Nenndrücke PN beziehen sich auf die Stahl- und Edelstahlversion der Verschraubung.

WGMTX Schottaufschraubstutzen

Triple-Lok® 37° Bördelanschluss / NPTF* Innengewinde (SAE J476)

*Edelstahl = NPT Gewinde

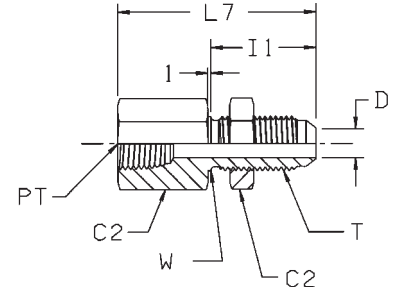

Rohr A.D.	Gewinde NPT/NPTF PT	Gewinde UN/UNF-2A T	C2	D	I1	L7	W	Gewicht (Stahl) g/1 St.	Triple-Lok® Stahl	Triple-Lok® Edelstahl	PN (bar)		
											mm	Zoll	S
6	1/4	1/8-27	7/16-20	17	4	31	47	11	42	4 WGTX-S	4WGMTXSS	420	350
6	1/4	1/4-18	7/16-20	19	4	34	54	11	62	4-4 WGTX-S	4-4WGMTXSS	420	350
10	3/8	1/4-18	9/16-18	21	8	33	52	14	72	6 WGTX-S	6WGMTXSS	420	350
12	1/2	3/8-18	3/4-16	25	10	37	59	19	117	8 WGTX-S	8WGMTXSS	420	350
14, 15, 16	5/8	1/2-14	7/8-14	29	12	40	68	22	179	10 WGTX-S	10WGMTXSS	350	350
18, 20	3/4	3/4-14	1 1/16-12	35	16	45	74	27	284	12 WGTX-S	12WGMTXSS	280	280
25	1	1-11 1/2	1 5/16-12	41	21	45	79	33	415	16 WGTX-S	16WGMTXSS	210	210

Die angegebenen Artikel entsprechen unserem Standard-Lieferprogramm.
Zöllige und metrische Versionen können sich in der Schlüsselweite unterscheiden.

$$\frac{\text{PN (bar)}}{10} = \text{PN (MPa)}$$

Die angegebenen Nenndrücke PN beziehen sich auf die Stahl- und Edelstahlversion der Verschraubung.



Maximale Schottwandstärke

Größe	Rohr A.D.		Gerade Schottverschraubung Max. Wandstärke mm	Form Schottverschraubung Max. Wandstärke mm
	Zoll	Metrisch		
4	1/4	6	8,4	5,3
5	5/16	8	8,4	5,3
6	3/8	10	10,7	7,1
8	1/2	12	11,2	8,4
10	5/8	14-16	10,9	8,1
12	3/4	18-20	11,2	8,6
14	7/8		10,4	7,9
16	1	22-25	9,9	7,4
20	1 1/4	28-32	10,2	7,4
24	1 1/2	35-38	7,1	—
32	2		7,1	—

DMTX Winkelaufschraubverschraubung

Triple-Lok® 37° Bördelanschluss / NPTF* Innengewinde (SAE J476)

SAE 070203 MS51506

*Edelstahl = NPT Gewinde

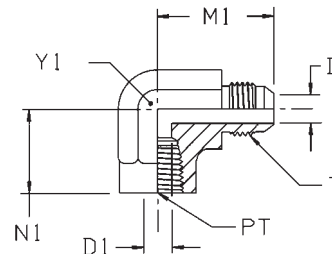

Rohr A.D.	mm	Zoll	Gewinde NPT/NPTF PT	Gewinde UN/UNF-2A T	D mm	D1 mm	M1 mm	N1 mm	Y1 mm	Gewicht (Stahl) g/1 St.	Triple-Lok®			PN (bar)	
											Stahl	Edelstahl	Messing	S	SS
6	1/4	1/8-27	7/16-20	4	8	27	17	14	33	4 DTX-S	4 DTX-SS	4 DTX-B	350	350	
6	1/4	1/4-18	7/16-20	4	11	31	22	19	70	4-4 DTX-S	4-4 DTX-SS	4-4 DTX-B	350	350	
8	5/16	1/8-27	1/2-20	6	8	27	17	14	33	5 DTX-S	5 DTX-SS	5 DTX-B	350	350	
8	5/16	1/4-18	1/2-20	6	11	29	22	19	67	5-4 DTX-S	5-4 DTX-SS	5-4 DTX-B	350	350	
10	3/8	1/4-18	9/16-18	8	11	31	22	19	67	6 DTX-S	6 DTX-SS	6 DTX-B	350	350	
10	3/8	1/8-27	9/16-18	8	8	31	17	14	39	6-2 DTX-S	6-2 DTX-SS	6-2 DTX-B	350	350	
10	3/8	3/8-18	9/16-18	8	14	33	26	22	103	6-6 DTX-S	6-6 DTX-SS	6-6 DTX-B	310	310	
12	1/2	3/8-18	3/4-16	10	14	36	26	22	115	8 DTX-S	8 DTX-SS	8 DTX-B	310	310	
12	1/2	1/4-18	3/4-16	10	11	36	26	19	190	8-4 DTX-S	8-4 DTX-SS	8-4 DTX-B	350	350	
12	1/2	1/2-14	3/4-16	10	18	39	31	27	178	8-8 DMTXS	8-8 DTX-SS	8-8 DTX-B	210	210	
14, 15, 16	5/8	1/2-14	7/8-14	12	18	42	31	27	180	10 DTX-S	10 DTX-SS	10 DTX-B	210	210	
18, 20	3/4	3/4-14	1 1/16-12	16	23	48	35	33	315	12 DMTXS	12 DTX-SS	12 DTX-B	210	210	
18, 20	3/4	1/2-14	1 1/16-12	16	18	48	34	27	175	12-8 DTX-S	12-8 DTX-SS	12-8 DTX-B	210	210	
22	7/8	3/4-14	1 3/16-12	18	23	47	36	33	285	14 DTX-S	14 DTX-SS		125	125	
25	1	1-11 1/2	1 5/16-12	21	29	55	41	41	506	16 DTX-S	16 DTX-SS	16 DTX-B	125	125	
28, 30, 32	1 1/4	1 1/4-11 1/2	1 5/8-12	27	37	59	43	48	619	20 DTX-S	20 DTX-SS	20 DTX-B	100	100	
35, 38	1 1/2	1 1/2-11 1/2	1 7/8-12	33	43	73	53	64	1725	24 DTX-S	24 DTX-SS		100	100	

Die angegebenen Artikel entsprechen unserem Standard-Lieferprogramm.
Zöllige und metrische Versionen können sich in der Schlüsselweite unterscheiden.

$$\frac{\text{PN (bar)}}{10} = \text{PN (MPa)}$$

Die angegebenen Nenndrücke PN beziehen sich auf die Stahl- und Edelstahlversion der Verschraubung.
Für Messingverschraubungen sind diese Drücke um 35% zu reduzieren.

OTX T-Aufschraubstutzen

Triple-Lok® 37° Bördelanschluss / NPTF* Innengewinde (SAE J476)

SAE 070427 MS51513

*Edelstahl = NPT Gewinde

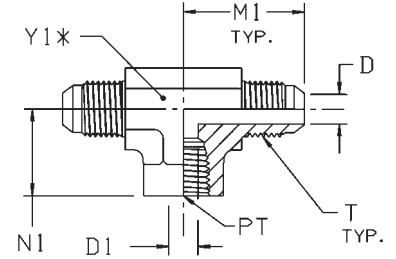

Rohr A.D.	Gewinde NPT/NPTF PT	Gewinde UN/UNF-2A T	D mm	D1 mm	M1 mm	N1 mm	Y1 mm	Gewicht (Stahl) g/1 St.	Triple-Lok® Stahl	Triple-Lok® Edelstahl	Triple-Lok® Messing	PN (bar)		
												S	SS	
6	1/4	1/8-27	7/16-20	4	8	27	17	14	53	4 OTX-S	4 OTX-SS	4 OTX-B	350	350
6	1/4	1/4-18	7/16-20	4	11	29	22	19	90	4-4-4 OTX-S	4-4-4 OTX-SS	4-4-4 OTX-B	350	350
8	5/16	1/8-27	1/2-20	6	8	27	17	14	53	5 OTX-S	5 OTX-SS	5 OTX-B	350	350
10	3/8	1/4-18	9/16-18	8	11	32	22	19	98	6 OTX-S	6 OTX-SS	6 OTX-B	350	350
12	1/2	3/8-18	3/4-16	10	14	36	26	22	145	8 OTX-S	8 OTX-SS	8 OTX-B	310	310
14, 15, 16	5/8	1/2-14	7/8-14	12	18	42	32	27	240	10 OTX-S	10 OTX-SS	10 OTX-B	210	210
18, 20	3/4	3/4-14	1 1/16-12	16	23	48	35	33	390	12 OTX-S	12 OTX-SS	12 OTX-B	210	210
25	1	1-11 1/2	1 5/16-12	21	29	55	41	41	745	16 OTX-S	16 OTX-SS	16 OTX-B	125	125
28, 30, 32	1 1/4	1 1/4-11 1/2	1 5/8-12	27	37	59	43	48	930	20 OTX-S	20 OTX-SS		100	100
35, 38	1 1/2	1 1/2-11 1/2	1 7/8-12	33	43	73	53	64	2255	24 OTX-S	24 OTX-SS		100	100

Die angegebenen Artikel entsprechen unserem Standard-Lieferprogramm.
Zöllige und metrische Versionen können sich in der Schlüsselweite unterscheiden.

$$\frac{\text{PN (bar)}}{10} = \text{PN (MPa)}$$

Die angegebenen Nenndrücke PN beziehen sich auf die Stahl- und Edelstahlversion der Verschraubung.
Für Messingverschraubungen sind diese Drücke um 35% zu reduzieren.

K

MTX L-Aufschraubstutzen

Triple-Lok® 37° Bördelanschluss / NPTF* Innengewinde (SAE J476)

SAE 070426 MS51514

*Edelstahl = NPT Gewinde

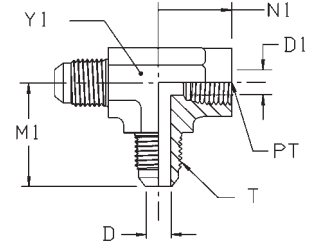

Rohr A.D. mm	Zoll	Gewinde NPT/NPTF PT	Gewinde UN/UNF-2A T	D mm	D1 mm	M1 mm	N1 mm	Y1 mm	Gewicht (Stahl) g/1 St.	Triple-Lok® Stahl	Triple-Lok® Edelstahl	Triple-Lok® Messing	PN (bar)	
													S	SS
6	1/4	1/8-27	7/16-20	4	8	27	17	14	45	4 MTX-S	4 MTX-SS	4 MTX-B	350	350
6	1/4	1/4-18	7/16-20	4	11	29	22	19	10	4-4-4 MTX-S	4-4-4 MTX-SS	4-4-4 MTX-B	350	350
10	3/8	1/4-18	9/16-18	8	11	32	22	19	88	6 MTX-S	6 MTX-SS	6 MTX-B	350	350
12	1/2	3/8-18	3/4-16	10	14	36	26	22	125	8 MTX-S	8 MTX-SS	8 MTX-B	310	310
14, 15, 16	5/8	1/2-14	7/8-14	12	18	42	32	27	210	10 MTX-S	10 MTX-SS	10 MTX-B	210	210
18, 20	3/4	3/4-14	1 1/16-12	16	23	48	35	33	280	12 MTX-S	12 MTX-SS	12 MTX-B	210	210
22	7/8	3/4-14	1 3/16-12	18	23	47	36	33	446	14 MTX-S			210	—
25	1	1-11 1/2	1 5/16-12	21	29	55	41	41	620	16 MTX-S	16 MTX-SS		125	125
28, 30, 32	1 1/4	1 1/4-11 1/2	1 5/8-12	27	37	59	43	48	805	20 MTX-S	20 MTX-SS		100	100

Die angegebenen Artikel entsprechen unserem Standard-Lieferprogramm.
Zöllige und metrische Versionen können sich in der Schlüsselweite unterscheiden.

$$\frac{\text{PN (bar)}}{10} = \text{PN (MPa)}$$

Die angegebenen Nenndrücke PN beziehen sich auf die Stahl- und Edelstahlversion der Verschraubung.
Für Messingverschraubungen sind diese Drücke um 35% zu reduzieren.

G6X Gerader Aufschraubstutzen

Triple-Lok® 37° Swivel, einstellbar / NPTF* Innengewinde (SAE J476)

*Edelstahl = NPT Gewinde

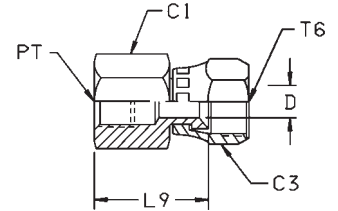

Rohr A.D. mm	Zoll	Gewinde NPT/NPTF PT	Gewinde UN/UNF-2B T6	C1 mm	C3 mm	D mm	L9 mm	Gewicht (Stahl) g/1 St.	Triple-Lok® Stahl	Triple-Lok® Edelstahl	PN (bar)	
											S	SS
6	1/4	1/8-27	7/16-20	14	14	5	23	29	4 G6X-S	4 G6X-SS	420	420
6	1/4	1/4-18	7/16-20	19	14	5	27	33	4-4 G6X-S	4-4 G6X-SS	420	420
10	3/8	1/4-18	9/16-18	19	17	8	27	38	6 G6X-S	6 G6X-SS	350	350
10	3/8	3/8-18	9/16-18	22	17	7	30	45	6-6 G6X-S	6-6 G6X-SS	350	350
12	1/2	3/8-18	3/4-16	22	22	10	31	47	8 G6X-S	8 G6X-SS	350	350
12	1/2	1/2-14	3/4-16	29	22	10	38	99	8-8 G6X-S	8-8 G6X-SS	350	350
14, 15, 16	5/8	1/2-14	7/8-14	29	25	12	37	99	10 G6X-S	10 G6X-SS	350	350
18, 20	3/4	3/4-14	1 1/16-12	35	32	16	38	147	12 G6X-S	12 G6X-SS	280	280
25	1	1-11 1/2	1 5/16-12	41	38	21	47	248	16 G6X-S	16 G6X-SS	210	210
28, 30, 32	1 1/4	1 1/4-11 1/2	1 5/8-12	50	50	28	55	370	20 G6X-S	20 G6X-SS	170	170
35, 38	1 1/2	1 1/2-12 1/2	1 7/8-12	60	58	34	57	510	24 G6X-S	24 G6X-SS	140	140

Die angegebenen Artikel entsprechen unserem Standard-Lieferprogramm.
Zöllige und metrische Versionen können sich in der Schlüsselweite unterscheiden.

$$\frac{\text{PN (bar)}}{10} = \text{PN (MPa)}$$

Die angegebenen Nenndrücke PN beziehen sich auf die Stahl- und Edelstahlversion der Verschraubung.

K

G4MXMO Manometerstutzen

Triple-Lok® 37° Bördelanschluss / Zöll. Innengewinde (ISO 1179-1) für Manometeranschluss

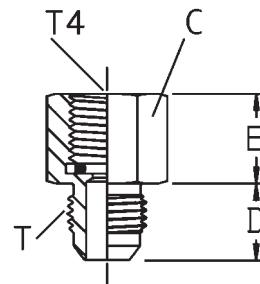

mm	Rohr A.D.		Gewinde BSPP T4	Gewinde UN/UNF-2A T	D mm	E mm	C mm	Gewicht (Stahl) g/1 St.	Triple-Lok® Stahl	Triple-Lok® Edelstahl	PN (bar)	
	Zoll										S	SS
6	1/4		1/4-19	7/16-20	14	17	17	86	4-4G4MXSMO	4-4G4MXSSMO	350	350
6	1/4		1/2-14	7/16-20	14	27	27	246	4-8G4MXSMO	4-8G4MXSSMO	315	315
8	5/16		1/4-19	1/2-20	14	14	17	49	5-4G4MXSMO	5-4G4MXSSMO	350	350
8	5/16		1/2-14	1/2-20	14	27	27	246	5-8G4MXSMO	5-8G4MXSSMO	315	315
10	3/8		1/4-19	9/16-18	14	14	17	49	6G4MXSMO	6G4MXSSMO	350	350
10	3/8		1/2-14	9/16-18	14	21	27	239	6-8G4MXSMO	6-8G4MXSSMO	315	315
12	1/2		1/4-19	3/4-16	17	14	19	74	8-4G4MXSMO	8-4G4MXSSMO	400	350
12	1/2		1/2-14	3/4-16	17	21	27	263	8-8G4MXSMO	8-8G4MXSSMO	315	315

Triple-Lok® Verschraubungen werden standardmäßig mit NBR Dichtung geliefert. Für alternative Dichtungswerkstoffe siehe Seite K93

Die angegebenen Artikel entsprechen unserem Standard-Lieferprogramm.

Zöllige und metrische Versionen können sich in der Schlüsselweite unterscheiden.

$$\frac{\text{PN (bar)}}{10} = \text{PN (MPa)}$$

Die angegebenen Nenndrücke PN beziehen sich auf die Stahl- und Edelstahlversion der Verschraubung.

TT4MX Adapter für Prüfanschluss

Triple-Lok® 37° Innengewinde / Zöll. Innengewinde (ISO 1179-1)
für EMA3-Messanschluss

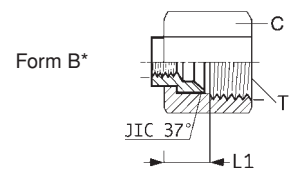
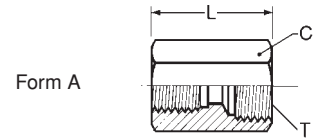

* Form B wird mit einer Mutter montiert.
BMTX / BTX nicht im Lieferumfang!

Rohr A.D. T		Gewinde BSP	Gewinde UN/UNF-2B T	Form	L mm	L1 mm	C mm	Gewicht (Stahl) g/1 St.	Triple-Lok® Stahl	Triple-Lok® Edelstahl	PN (bar)	
mm	Zoll										S	SS
6	1/4	1/4-19	7/16-20	A	29	–	19	42	4TT4MXS	4TT4MXSS	400	350
8	5/16	1/4-19	1/2-20	A	29	–	19	46	5TT4MXS	5TT4MXSS	400	350
10	3/8	1/4-19	9/16-18	A	29	–	19	43	6TT4MXS	6TT4MXSS	400	350
12	1/2	1/4-19	3/4-16	A	32	–	22	62	8TT4MXS	8TT4MXSS	400	350
14, 15, 16	5/8	1/4-19	7/8-14	A	32	–	27	102	10TT4MXS	10TT4MXSS	350	350
18, 20	3/4	1/4-19	1 1/16-12	B	–	13	32	42	12TT4XS	12TT4MXSS	350	350
25	1	1/4-19	1 5/16-12	B	–	13	41	56	16TT4XS	16TT4MXSS	280	280
28, 30, 32	1 1/4	1/4-19	1 5/8-12	B	–	15	50	98	20TT4XS	20TT4MXSS	280	210
35, 38	1 1/2	1/4-19	1 7/8-12	B	–	18	60	185	24TT4XS	24TT4MXSS	210	210

Die angegebenen Artikel entsprechen unserem Standard-Lieferprogramm.
Zöllige und metrische Versionen können sich in der Schlüsselweite unterscheiden.

$$\frac{\text{PN (bar)}}{10} = \text{PN (MPa)}$$

Die angegebenen Nenndrücke PN beziehen sich auf die Stahl- und Edelstahlversion der Verschraubung.

TTP4MX Adapter für Prüfanschluß

Triple-Lok® 37° Innengewinde / EMA3 Messanschluss

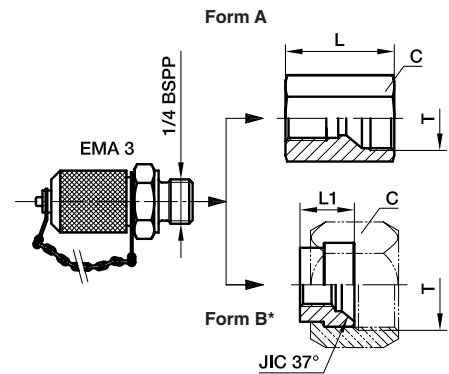

* Form B-Teile werden komplett mit BMTXS-Mutter geliefert.

Rohr A.D. T	Gewinde BSPP	Gewinde UN/UNF-2B T	Form	L mm	L1 mm	C mm	Gewicht (Stahl) g/1 St.	Triple-Lok® Stahl	PN (bar)
6	1/4	1/4-19	A	29	–	19	132	4TTP4MXS	400
8	5/16	1/4-19	A	29	–	19	136	5TTP4MXS	400
10	3/8	1/4-19	A	29	–	19	133	6TTP4MXS	400
12	1/2	1/4-19	A	32	–	22	152	8TTP4MXS	400
14, 15, 16	5/8	1/4-19	A	32	–	27	192	10TTP4MXS	350
18, 20	3/4	1/4-19	B	–	13	32	132	12TTP4XS	350
25	1	1/4-19	B	–	13	41	146	16TTP4XS	280
28, 30, 32	1 1/4	1/4-19	B	–	15	50	188	20TTP4XS	280
35, 38	1 1/2	1/4-19	B	–	18	60	275	24TTP4XS	210

Die angegebenen Artikel entsprechen unserem Standard-Lieferprogramm.
Zöllige und metrische Versionen können sich in der Schlüsselweite unterscheiden.

$$\frac{\text{PN (bar)}}{10} = \text{PN (MPa)}$$

R6O4MX Adapter für Prüfanschluss

Triple-Lok® 37° Bördelanschluss / Swivel, einstellbar / Zöll. Innengewinde (ISO 1179-1)

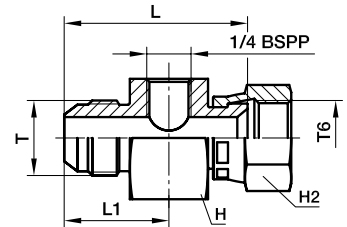

Rohr A.D. T	Gewinde UN/UNF-2A T	Gewinde UN/UNF-2B T6	L mm	L1 mm	H mm	H2 mm	Gewicht (Stahl) g/1 St.	Triple-Lok® Stahl	PN (bar)
6	1/4	7/16-20	45	26	36	16	180	4-4R6O4MXS	500
8	5/16	1/2-20	46	26	36	17	200	5-4R6O4MXS	420
10	3/8	9/16-18	47	26	36	19	210	6-4R6O4MXS	350
12	1/2	3/4-16	50	28	36	22	218	8-4R6O4MXS	350
14, 15, 16	5/8	7/8-14	54	31	36	27	247	10-4R6O4MXS	350
18, 20	3/4	1 1/16-12	56	34	41	32	326	12-4R6O4MXS	350
25	1	1 5/16-12	60	35	46	38	416	16-4R6O4MXS	250
28, 30, 32	1 1/4	1 5/8-12	64	36	50	50	601	20-4R6O4MXS	250
35, 38	1 1/2	1 7/8-12	69	39	60	60	905	24-4R6O4MXS	170

Die angegebenen Artikel entsprechen unserem Standard-Lieferprogramm.
Zöllige und metrische Versionen können sich in der Schlüsselweite unterscheiden.

$$\frac{\text{PN (bar)}}{10} = \text{PN (MPa)}$$



R6P4MX Adapter für Prüfanschluß

Triple-Lok® 37° Bördelanschluss / Swivel, einstellbar / EMA3 Messanschluss

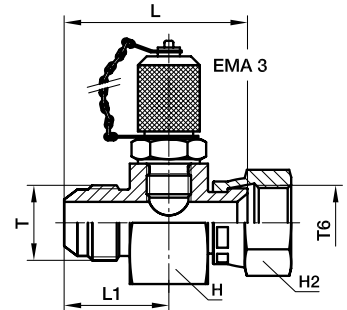

Rohr A.D. T mm	Zoll	Gewinde UN/UNF-2A T	Gewinde UN/UNF-2B T6	L mm	L1 mm	H mm	H2 mm	Gewicht (Stahl) g/1 St.	Triple-Lok® Stahl	PN (bar)
6	1/4	7/16-20	7/16-20	45	26	36	16	270	4-4R6P4MXS	500
8	5/16	1/2-20	1/2-20	46	26	36	17	290	5-4R6P4MXS	420
10	3/8	9/16-18	9/16-18	47	26	36	19	300	6-4R6P4MXS	350
12	1/2	3/4-16	3/4-16	50	28	36	22	308	8-4R6P4MXS	350
14, 15, 16	5/8	7/8-14	7/8-14	54	31	36	27	337	10-4R6P4MXS	350
18, 20	3/4	1 1/16-12	1 1/16-12	56	34	41	32	416	12-4R6P4MXS	350
25	1	1 5/16-12	1 5/16-12	60	35	46	38	506	16-4R6P4MXS	250
28, 30, 32	1 1/4	1 5/8-12	1 5/8-12	64	36	50	50	691	20-4R6P4MXS	250
35, 38	1 1/2	1 7/8-12	1 7/8-12	69	39	60	60	995	24-4R6P4MXS	170

Die angegebenen Artikel entsprechen unserem Standard-Lieferprogramm.
Zöllige und metrische Versionen können sich in der Schlüsselweite unterscheiden.

$$\frac{\text{PN (bar)}}{10} = \text{PN (MPa)}$$

K6004MX Adapter für Prüfanschluss

Triple-Lok® 37° Bördelanschluss / Swivel, einstellbar / 2x BSPP Innengewinde

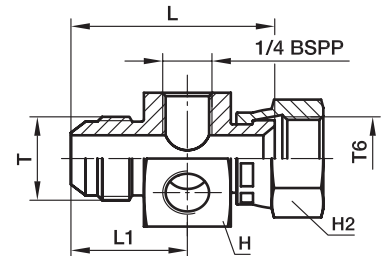

Rohr A.D. T	Gewinde UN/UNF-2A T	Gewinde UN/UNF-2B T6	L mm	L1 mm	H mm	H2 mm	Gewicht (Stahl) g/1 St.	Triple-Lok® Stahl	PN (bar)
6	1/4	7/16-20	45	26	36	16	170	4-4K6004MXS	500
8	5/16	1/2-20	46	26	36	17	190	5-4K6004MXS	420
10	3/8	9/16-18	47	26	36	19	200	6-4K6004MXS	350
12	1/2	3/4-16	50	28	36	22	208	8-4K6004MXS	350
14, 15, 16	5/8	7/8-14	54	31	36	27	237	10-4K6004MXS	350
18, 20	3/4	1 1/16-12	56	34	41	32	316	12-4K6004MXS	350
25	1	1 5/16-12	60	35	46	38	406	16-4K6004MXS	250

Die angegebenen Artikel entsprechen unserem Standard-Lieferprogramm.
Zöllige und metrische Versionen können sich in der Schlüsselweite unterscheiden.

$$\frac{\text{PN (bar)}}{10} = \text{PN (MPa)}$$

K

K6PP4MX Adapter für Prüfanschluss

Triple-Lok® 37° Bördelanschluss / Swivel, einstellbar / montiert mit EMA3 & VSTI

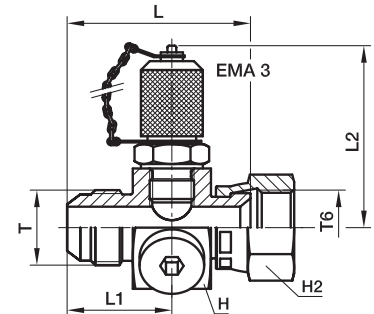

Rohr A.D. T mm	Zoll	Gewinde UN/UNF-2A T	Gewinde UN/UNF-2B T6	L mm	L1 mm	L2 mm	H mm	H2 mm	Gewicht (Stahl) g/1 St.	Triple-Lok® Stahl	PN (bar)
6	1/4	7/16-20	7/16-20	45	26	54	36	16	270	4-4K6PP4MXS	500
8	5/16	1/2-20	1/2-20	46	26	54	36	17	290	5-4K6PP4MXS	420
10	3/8	9/16-18	9/16-18	47	26	54	36	19	300	6-4K6PP4MXS	350
12	1/2	3/4-16	3/4-16	50	28	54	36	22	308	8-4K6PP4MXS	350
14, 15, 16	5/8	7/8-14	7/8-14	54	31	54	36	27	337	10-4K6PP4MXS	350
18, 20	3/4	1 1/16-12	1 1/16-12	56	34	54	41	32	416	12-4K6PP4MXS	350
25	1	1 5/16-12	1 5/16-12	60	35	54	46	38	506	16-4K6PP4MXS	250

Die angegebenen Artikel entsprechen unserem Standard-Lieferprogramm.
Zöllige und metrische Versionen können sich in der Schlüsselweite unterscheiden.

$$\frac{\text{PN (bar)}}{10} = \text{PN (MPa)}$$

FNMTX Verschlusskappe

Triple-Lok® 37° Verschlusskappe
SAE 070112 MS51532

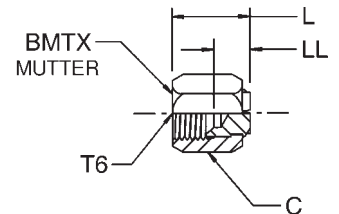

Rohr A.D.		Gewinde UN/UNF-2B T6	C mm	LL mm	L mm	Gewicht (Stahl) g/1 St.	Triple-Lok® Stahl	Triple-Lok® Edelstahl	Triple-Lok® Messing	PN (bar)	
mm	Zoll									S	SS
6	1/8	5/16-24	10	10	15	10	2 FNTX-S			500	—
	3/16	3/8-24	11	10	17	11	3 FNTX-S			500	—
	1/4	7/16-20	14	9	17	14	4FNMTXS	4FNMTXSS	4 FNTX-B	500	350
	5/16	1/2-20	17	10	20	19	5FNMTXS	5FNMTXSS	5 FNTX-B	420	350
8	3/8	9/16-18	19	12	21	31	6FNMTXS	6FNMTXSS	6 FNTX-B	420	350
10	1/2	3/4-16	22	14	24	45	8FNMTXS	8FNMTXSS	8 FNTX-B	420	350
14, 15, 16	5/8	7/8-14	27	14	27	75	10FNMTXS	10FNMTXSS	10 FNTX-B	350	350
18, 20	3/4	1 1/16-12	32	17	32	114	12FNMTXS	12FNMTXSS	12 FNTX-B	350	350
22	7/8	1 3/16-12	35	16	32	133	14 FNTX-S	14FNMTXSS	14 FNTX-B	310	280
25	1	1 5/16-12	41	16	33	200	16FNMTXS	16FNMTXSS	16 FNTX-B	310	280
28, 30, 32	1 1/4	1 5/8-12	50	19	35	272	20FNMTXS	20FNMTXSS	20 FNTX-B	280	210
35, 38	1 1/2	1 7/8-12	60	24	43	553	24FNMTXS	24FNMTXSS	24 FNTX-B	210	140
	2	2 1/2-12	73	28	51	930	32 FNTX-S			140	—

Die angegebenen Artikel entsprechen unserem Standard-Lieferprogramm.
Zöllige und metrische Versionen können sich in der Schlüsselweite unterscheiden.

$$\frac{\text{PN (bar)}}{10} = \text{PN (MPa)}$$

Die angegebenen Nenndrücke PN beziehen sich auf die Stahl- und Edelstahlversion der Verschraubung.
Für Messingverschraubungen sind diese Drücke um 35% zu reduzieren.

K

PNMTX Verschlußstutzen

Triple-Lok® 37° Verschlußstutzen
SAE 070109 MS51518

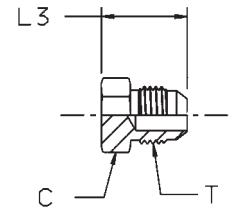

Rohr A.D. mm	Zoll	Gewinde UN/UNF-2A T	C mm	L3 mm	Gewicht (Stahl) g/1 St.	Triple-Lok® Stahl	Triple-Lok® Edelstahl	PN (bar)	
								S	SS
6	1/8	5/16-24	11	18	9	2 PNTX-S		500	—
	3/16	3/8-24	11	19	10	3 PNTX-S		500	—
	1/4	7/16-20	13	20	10	4PNMTXS	4PNMTXSS	500	350
	5/16	1/2-20	14	20	14	5PNMTXS	5PNMTXSS	420	350
	3/8	9/16-18	17	21	19	6PNMTXS	6PNMTXSS	420	350
14, 15, 16	1/2	3/4-16	19	24	39	8PNMTXS	8PNMTXSS	420	350
	5/8	7/8-14	24	28	60	10PNMTXS	10PNMTXSS	350	350
	3/4	1 1/16-12	27	33	93	12PNMTXS	12PNMTXSS	350	350
	7/8	1 3/16-12	32	33	95	14 PNTX-S	14PNMTXSS	280	280
	1	1 5/16-12	36	34	98	16PNMTXS	16PNMTXSS	280	280
28, 30, 32	1 1/4	1 5/8-12	46	37	269	20PNMTXS	20PNMTXSS	280	210
	1 1/2	1 7/8-12	51	42	360	24 PNTX-S	24PNMTXSS	210	140
		2	2 1/2-12	67	52	470	32 PNTX-S		140

Die angegebenen Artikel entsprechen unserem Standard-Lieferprogramm.
Zöllige und metrische Versionen können sich in der Schlüsselweite unterscheiden.

$$\frac{\text{PN (bar)}}{10} = \text{PN (MPa)}$$

Die angegebenen Nenndrücke PN beziehen sich auf die Stahl- und Edelstahlversion der Verschraubung.

XHMLO Anschluss-Adapter

Triple-Lok® 37° Bördelanschluss / O-Lok ORFS Anschluss

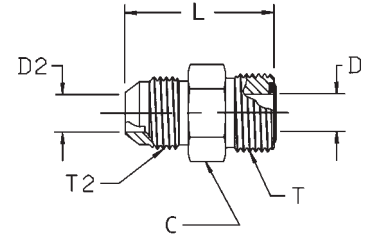

Rohr A.D. T2/T mm	Zoll	Gewinde UN/UNF-2A T2	Gewinde UN/UNF-2A T	D mm	D2 mm	L mm	C mm	Gewicht (Stahl) g/1 St.	Triple-Lok® Stahl	Triple-Lok® Edelstahl	PN (bar)	
											S	SS
6	1/4	7/16-20	9/16-18	5	5	32	16	29	4 XHLO-S	4XHMLOSS	500	350
8, 10	5/16, 3/8	9/16-18	11/16-16	7	7	34	19	45	6 XHLO-S	6XHMLOSS	420	350
12	1/2	3/4-16	13/16-16	10	10	39	22	70	8 XHLO-S	8XHMLOSS	420	350
14, 15, 16	5/8	7/8-14	1-14	13	13	47	27	119	10 XHLO-S	10XHMLOSS	350	350
18, 20	3/4	1 1/16-12	1 3/16-12	16	16	52	32	181	12 XHLO-S	12XHMLOSS	350	350
22, 25	1	1 5/16-12	1 7/16-12	21	21	55	38	265	16 XHLO-S	16XHMLOSS	280	280
28, 30, 32	1 1/4	1 5/8-12	1 11/16-12	26	26	58	45	383	20 XHLO-S	20XHMLOSS	280	210
35, 38	1 1/2	1 7/8-12	2-12	32	32	63	54	562	24 XHLO-S	24XHMLOSS	210	140

Triple-Lok® Verschraubungen werden standardmäßig mit NBR Dichtung geliefert. Für alternative Dichtungswerkstoffe siehe Seite K93

Die angegebenen Artikel entsprechen unserem Standard-Lieferprogramm.

Zöllige und metrische Versionen können sich in der Schlüsselweite unterscheiden.

$$\frac{\text{PN (bar)}}{10} = \text{PN (MPa)}$$

Die angegebenen Nenndrücke PN beziehen sich auf die Stahl- und Edelstahlversion der Verschraubung.

K

XHML6 Anschluss-Adapter

Triple-Lok® 37° Bördelanschluss / O-Lok ORFS Swivel, einstellbar

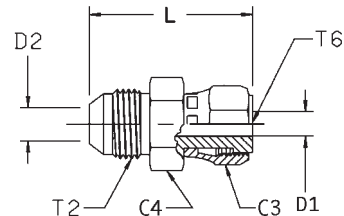

Rohr A.D. T2/T6		Gewinde UN/UNF-2A T2	Gewinde UN/UNF-2B T6	C3 mm	D1 mm	D2 mm	L mm	C4 mm	Gewicht (Stahl) g/1 St.	Triple-Lok® Stahl	Triple-Lok® Edelstahl	PN (bar)	
mm	Zoll											S	SS
6	1/4	7/16-20	9/16-18	17	4	4	38	16	29	4 XHL6-S	4XHML6SS	500	350
8, 10	5/16, 3/8	9/16-18	11/16-16	21	7	7	41	19	46	6 XHL6-S	6XHML6SS	420	350
12	1/2	3/4-16	13/16-16	24	9	9	48	22	73	8 XHL6-S	8XHML6SS	420	350
14, 15, 16	5/8	7/8-14	1-14	29	12	12	56	27	126	10 XHL6-S	10XHML6SS	350	350
18, 20	3/4	1 1/16-12	1 3/16-12	35	14	14	64	32	205	12 XHL6-S	12XHML6SS	350	350
22, 25	1	1 5/16-12	1 7/16-12	41	20	20	68	38	285	16 XHL6-S	16XHML6SS	280	280
28, 30, 32	1 1/4	1 5/8-12	1 11/16-12	48	26	26	71	43	360	20 XHL6-S	20XHML6SS	280	280

Die angegebenen Artikel entsprechen unserem Standard-Lieferprogramm.
Zöllige und metrische Versionen können sich in der Schlüsselweite unterscheiden.

$$\frac{\text{PN (bar)}}{10} = \text{PN (MPa)}$$

Die angegebenen Nenndrücke PN beziehen sich auf die Stahl- und Edelstahlversion der Verschraubung.

LOHMX6 Gerader Adapter

Triple-Lok® 37° Swivel, einstellbar / O-Lok ORFS Anschluss

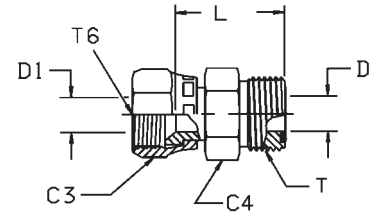

Rohr A.D. T6/T		Gewinde UN/UNF-2B T6	Gewinde UN/UNF-2A T	C3 mm	D mm	D1 mm	C4 mm	L mm	Gewicht (Stahl) g/1 St.	Triple-Lok® Stahl	Triple-Lok® Edelstahl	PN (bar)	
mm	Zoll											S	SS
6	1/4	7/16-20	9/16-18	14	5	5	16	26	26	4 LOHX6-S	4LOHMX6SS	500	350
8, 10	5/16, 3/8	9/16-18	11/16-16	18	7	7	19	29	40	6 LOHX6-S	6LOHMX6SS	350	350
12	1/2	3/4-16	13/16-16	22	10	10	22	34	63	8 LOHX6-S	8LOHMX6SS	350	350
14, 15, 16	5/8	7/8-14	1-14	25	13	13	27	39	103	10 LOHX6-S	10LOHMX6SS	350	350
18, 20	3/4	1 1/16-12	1 3/16-12	32	16	16	32	41	162	12 LOHX6-S	12LOHMX6SS	350	350
22, 25	1	1 5/16-12	1 7/16-12	38	21	21	38	46	229	16 LOHX6-S	16LOHMX6SS	250	250

Triple-Lok® Verschraubungen werden standardmäßig mit NBR Dichtung geliefert. Für alternative Dichtungswerkstoffe siehe Seite K93

Die angegebenen Artikel entsprechen unserem Standard-Lieferprogramm.

Zöllige und metrische Versionen können sich in der Schlüsselweite unterscheiden.

$$\frac{\text{PN (bar)}}{10} = \text{PN (MPa)}$$

Die angegebenen Nenndrücke PN beziehen sich auf die Stahl- und Edelstahlversion der Verschraubung.



WLNM Schottgegenmutter

Gegenmutter für Schottstutzen
SAE 080118 MS51860

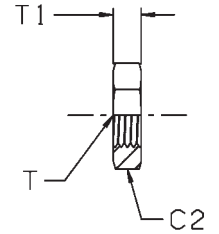

Gewinde UN/UNF-2B T	C2 mm	T1 mm	Gewicht (Stahl) g/1 St.	Triple-Lok® Stahl	Triple-Lok® Edelstahl	Triple-Lok® Messing
3/8-24	17	6	9	3 WLN-S		
7/16-20	17	7	9	4WLNMS	4WLNMS	4WLNMB
1/2-20	19	7	9	5WLNMS	5WLNMS	5WLNMB
9/16-18	22	7	11	6WLNMS	6WLNMS	6WLNMB
3/4-16	24	8	18	8WLNMS	8WLNMS	8WLNMB
7/8-14	30	9	24	10WLNMS	10WLNMS	10WLNMB
1 1/16-12	36	10	42	12WLNMS	12WLNMS	12WLNMB
1 3/16-12	38	10	45	14 WLN-S	14WLNMS	14WLNMB
1 5/16-12	41	10	49	16WLNMS	16WLNMS	16WLNMB
1 5/8-12	50	10	50	20WLNMS	20WLNMS	20WLNMB
1 7/8-12	55	10	68	24WLNMS	24WLNMS	24WLNMB
2 1/2-12	70	10	80	32 WLN-S		

Die angegebenen Artikel entsprechen unserem Standard-Lieferprogramm.
Zöllige und metrische Versionen können sich in der Schlüsselweite unterscheiden.

Triple-Lok® Kammerringe und O-Ringe

zöll. Einschraubzapfen – ISO 1179

BSPP Gewinde	ED-Dichtungring Bestellzeichen		O-Ring Bestellzeichen*		O-Ring ID × Schnurstärke (mm)	Kammerring Bestellzeichen Stahl	Kammerring Bestellzeichen Edelstahl
	NBR	FKM	NBR	FKM			
1/8	ED10X1X	ED10X1VITX	6-002-N552-9	6-002-V894-9	8.00 × 2.00	8207-1/8	8207SS1/8
1/4	ED14X1.5X	ED14X1.5VITX	2-111-N552-9	2-111-V894-9	10.77 × 2.62	8207-1/4	8207SS1/4A
3/8	ED3/8X	ED3/8VITX	2-113-N552-9	2-113-V894-9	13.94 × 2.62	8207-3/8	8207SS3/8A
1/2	ED1/2X	ED1/2VITX	5-256-N552-9	5-256-V894-9	17.96 × 2.62	8207-1/2	8207SS1/2
3/4	ED26X1.5X	ED26X1.5VITX	2-119-N552-9	2-119-V894-9	23.47 × 2.62	8207-3/4	8207SS3/4
1	ED33X2X	ED33X2VITX	2-217-N552-9	2-217-V894-9	29.74 × 3.53	8207-1	8207SS1A
1 1/4	ED42X2X	ED42X2VITX	2-222-N552-9	2-222-V894-9	37.69 × 3.53	8207-1-1/4	8207SS1 1/4
1 1/2	ED48X2X	ED48X2VITX	2-224-N552-9	2-224-V894-9	44.04 × 3.53	8207-1-1/2	8207SS1 1/2

z. B. F42EDMX / F4OMX / C4OMX / V4OMX etc.

*O-Ringe sind immer mit entsprechendem Kammerring zu verwenden

metr. Einschraubzapfen – ISO 9974

Metr. Gewinde	ED-Dichtring Bestellzeichen		O-Ring Bestellzeichen*		O-Ring ID × Schnurstärke (mm)	Kammerring Bestellzeichen Stahl	Kammerring Bestellzeichen Edelstahl
	NBR	FKM	NBR	FKM			
M10x1	ED10X1X	ED10X1VITX	6-074-N552-9	6-074-V894-9	8.00 × 1.50	M10RR	RRM10X1SS
M12x1.5	ED12X1.5X	ED12X1.5VITX	2-012-N552-9	2-012-V894-9	9.25 × 1.78	M12RR	RRM12X1.5SS
M14x1.5	ED14X1.5X	ED14X1.5VITX	2-013-N552-9	2-013-V894-9	10.82 × 1.78	M14RR	RRM14X1.5SS
M16x1.5	ED16X1.5X	ED16X1.5VITX	3-907-N552-9	3-907-V894-9	13.46 × 2.08	M16RR	RRM16X1.5SS
M18x1.5	ED18X1.5X	ED18X1.5VITX	2-114-N552-9	2-114-V894-9	15.54 × 2.62	M18RR	RRM18X1.5SS
M22x2	ED22X1.5X	ED22X1.5VITX	2-018-N552-9	2-018-V894-9	18.77 × 1.78	M22RR	RRM22X1.5SS
M27x2	ED26X1.5X**	ED26X1.5VITX	2-119-N552-9	2-119-V894-9	23.47 × 2.62	M27RR	RRM27X2SS
M33x2	ED33X2X	ED33X2VITX	2-122-N552-9	2-122-V894-9	28.24 × 2.62	M33RR	RRM33X2SS
M42x2	ED42X2X	ED42X2VITX	2-128-N552-9	2-128-V894-9	37.77 × 2.62	M42RR	RRM42X2SS
M48x2	ED48X2X	ED48X2VITX	2-132-N552-9	2-132-V894-9	44.12 × 2.62	M48RR	RRM48X2SS

z. B. F82EDMX / F8OMX / C8OMX / V8OMX etc.

*O-Ringe sind immer mit entsprechendem Kammerring zu verwenden

**gleicher Dichtring für M26X1.5 und M27X2

UN / UNF Einschraubzapfen – ISO 11926

UN / UNF Gewinde	Größe	O-Ring Bestellzeichen*		O-Ring ID x Schnurstärke (mm)
		NBR	FKM	
5/16-24	2	3-902-N552-9	3-902-V894-9	6.07 × 1.63
3/8-24	3	3-903-N552-9	3-903-V894-9	7.65 × 1.63
7/16-20	4	3-904-N552-9	3-904-V894-9	8.92 × 1.83
1/2-20	5	3-905-N552-9	3-905-V894-9	10.52 × 1.83
9/16-18	6	3-906-N552-9	3-906-V894-9	11.89 × 1.98
3/4-16	8	3-908-N552-9	3-908-V894-9	16.36 × 2.21
7/8-14	10	3-910-N552-9	3-910-V894-9	19.18 × 2.46
1 1/16-12	12	3-912-N552-9	3-912-V894-9	23.47 × 2.95
1 3/16-12	14	3-914-N552-9	3-914-V894-9	26.59 × 2.95
1 5/16-12	16	3-916-N552-9	3-916-V894-9	29.74 × 2.95
1 5/8-12	20	3-920-N552-9	3-920-V894-9	37.47 × 3.00
1 7/8-12	24	3-924-N552-9	3-924-V894-9	43.69 × 3.00
2 1/2-12	32	3-932-N552-9	3-932-V894-9	59.36 × 3.00

z. B. F5OMX / C5OMX / R5OMX etc.

metr. Einschraubzapfen – ISO 6149

Metr. Gewinde	O-Ring Bestellzeichen*		O-Ring ID × Schnurstärke (mm)
	NBR	FKM	
M10 × 1	6-345-N552-9	6-345-V894-9	8.20 × 1.50
M12 × 1.5	6-346-N552-9	6-346-V894-9	9.40 × 2.10
M14 × 1.5	6-347-N552-9	6-347-V894-9	11.40 × 2.10
M16 × 1.5	6-348-N552-9	6-348-V894-9	13.40 × 2.10
M18 × 1.5	6-349-N552-9	6-349-V894-9	15.40 × 2.10
M22 × 1.5	6-350-N552-9	6-350-V894-9	19.40 × 2.10
M27 × 2	6-351-N552-9	6-351-V894-9	23.70 × 2.80
M33 × 2	6-352-N552-9	6-352-V894-9	29.70 × 2.80
M42 × 2	6-353-N552-9	6-353-V894-9	38.70 × 2.80
M48 × 2	6-354-N552-9	6-354-V894-9	46.70 × 2.80

z. B. F87OMX / S87OMX etc.

Andere Dichtungswerkstoffe auf Anfrage erhältlich



EO[®] Ermeto Original
Schweiß-
verschraubungen

